

Atlas Concorde
SPA
WELLNESS&RELAX



Grès Fine Porcellanato Rettificato Monocalibro
Fine Porcelain Stoneware Rectified Monocaliber

ETIC



atlas concorde



MADE IN ITALY

Espressione di stile, qualità, etica
Expression of style, quality, ethics
Expression de style, qualité, éthique
Der Ausdruck des Stiles, der Qualität und Ethik
Expresión de estilo, calidad, ética
Воплощение стиля, качества, этики



Ceramics of Italy



www.ecolabel.eu

Gres porcellanato colorato in massa / Porcelain stoneware coloured in body
Gres cerame colore dans la masse / Durchgefärbtes feinsteinzeug
Gres porcelánico coloreado en masa / Керамический гранит окрашенный в массе

ETIC
contemporary natural feeling



Ebano



Rovere Grigio



Palissandro



Ulivo



Rovere



Rovere Bianco



ETIC ESSENCES

Noce

Equilibrio perfetto tra naturalezza e resistenza

Le intense sensazioni di naturalezza e autenticità delle essenze legno non trattate rivivono in una finitura ceramica sofisticata, per la progettazione di ambienti dall'atmosfera emozionante anche in contesti che richiedono caratteristiche tecniche di alto livello. Etic propone un'accuratissima selezione di sette pregiate essenze legno, ognuna caratterizzata da storia, estetica e fascino propri, che le rendono uniche e irripetibili.

Equilibre parfait entre authenticité et résistance. L'intensité des sensations de naturel et d'authenticité qu'offrent les essences non traitées revivent dans cette finition céramique sophistiquée qui permet de concevoir des espaces chargés d'une atmosphère émouvante même quand le contexte exige des caractéristiques techniques de haut niveau. Etic propose une sélection rigoureuse de sept essences précieuses dont chacune possède une histoire, un aspect esthétique et un charme qui lui sont propres et la rendent unique et inimitable.

Vollkommenes Gleichgewicht zwischen Natürlichkeit und Festigkeit. Die intensiven Empfindungen von Natürlichkeit und Authentizität der unbehandelten Holzessenzen leben in einem raffinierten Keramikfinish wieder auf und eignen sich hervorragend für die Gestaltung von Ambienten mit gefühlvoller Atmosphäre, auch in Kontexten, die technische Eigenschaften auf hohem Niveau erfordern. Sorgfältig ausgewählt ist Etic in sieben kostbaren Holzessenzen erhältlich, jede einzelne charakterisiert durch Geschichte, Ästhetik und ganz eigenen Charme, was sie einzigartig und unnachahmlich macht.

A perfect balance of naturalness and resistance

The intense sensations of naturalness and genuineness of untreated wood essences come to life in a sophisticated ceramic finishing, to create venues with emotional atmospheres even in contexts requiring high technical performance. Etic offers an accurate selection of seven fine wood essences, each with its own tradition, look and charm, therefore unique and unrepeatable.

Equilibrio perfecto entre naturalidad y resistencia. Las intensas sensaciones de naturalidad y autenticidad de las maderas no tratadas reviven en un acabado cerámico sofisticado, para el diseño de ambientes de atmósfera emocionante incluso en contextos que requieren características técnicas de alto nivel. Etic propone una cuidadosa selección de siete preciadas maderas, cada una de ellas caracterizada por una historia, estética y encanto propios, que las hacen únicas e irrepitibles.

Гармоничное сочетание натуральности и стойкости. Насыщенная, подлинная натуральность необработанного дерева оживает в изысканной керамической коллекции, способной наполнить волнующей атмосферой любые интерьеры или экстерьеры, даже те, в которых от оформительского материала требуются предельно высокие технические качества. Etic предлагает аккуратный подбор семи ценных пород дерева, у каждой из которых своя история, своя уникальная эстетика, свой шарм.



ETIC SURFACES



Doppia finitura, sicurezza in ogni applicazione

Etic propone due finiture superficiali: matt con un'estetica naturale dalla mano morbida e microstrutture che richiamano i legni dal fascino leggermente vissuto, e strutturata, che riproduce la lavorazione "piano sega", con un effetto tridimensionale ricco di suggestioni. Dotato di eccellenti qualità tecniche, Etic è ideale per un uso in esterno e negli ambienti che necessitano dei massimi standard di resistenza e sicurezza.

Deux finitions de surface, sécurité pour chaque application. Etic propose deux finitions de surface: la variante mate, à l'aspect naturel et douce au toucher, avec des microstructures qui rappellent le charme du bois légèrement patiné; la variante structurée reproduit l'aspect brut de sciage par un effet 3D richement suggestif. Dotée d'excellentes qualités techniques, la collection Etic est idéale pour une utilisation à l'extérieur et dans les espaces qui exigent les plus hauts standards de résistance et de sécurité.

Zwei Oberflächenfinishes, Sicherheit für jede Anwendung. Etic ist in zwei Oberflächenfinishes erhältlich: Matt mit einer ganz natürlichen, äußerst weichen Ästhetik und Mikrostrukturen, die an den Charme von abgelebtem Holz erinnern. Die strukturierte Variante erinnert an eine sägerauhe Bearbeitung mit einem dreidimensionalen Effekt voller Empfindungen. Ausgestattet mit exzellenten technischen Eigenschaften erweist sich Etic als ideal für eine Verwendung in Außenbereichen und in Kontexten, in denen maximale Standards in Sachen Strapazierfähigkeit und Sicherheit erforderlich sind.

Two surface finishes, safety in every application

The Etic collection offers two surface finishes: a matt finish featuring a delicate natural aesthetic with almost invisible microstructures evoking the fascination of slightly lived woods and a textured finish that reproduces the "saw cutting" processing, with a 3D effect full of charm. Having excellent technical qualities, it is perfect for outdoor applications and wherever the utmost standards of resistance and safety are required.

Dos acabados superficiales, seguridad en todas las aplicaciones. Etic propone dos acabados superficiales: mate, con una estética natural de mano suave y microestructuras que evocan las maderas de encanto vivido, y estructurado, que reproduce la elaboración de la madera de corte áspero, con un efecto tridimensional rico de sugerencias. Dotado de excelentes características técnicas, Etic es ideal para un uso en exteriores y en los ambientes que necesitan los máximos estándares de resistencia y seguridad.

Два варианта поверхности, безопасность в любых условиях. Плитки коллекции Etic представлены в двух вариантах поверхности: матовая поверхность отличается мягким натуральным видом и почти неосознаваемой микроструктурой, напоминающей слегка состаренное дерево; структурный же вариант воспроизводит фактуру пиленной древесины с выразительным трёхмерным эффектом. Благодаря своим превосходным техническим качествам коллекция идеальна для применения в экстерьерах и во всех тех условиях, где к материалам предъявляются самые высокие требования по стойкости и безопасности.



Spa&Beauty Club, London

Etic Essences: Noce 22,5x90, Noce Strutturato 22,5x90, Noce Tatami 22,5x90

Matching Surfaces: Advance Bianco Brera 45x90

Floor installation: Straightforward installation

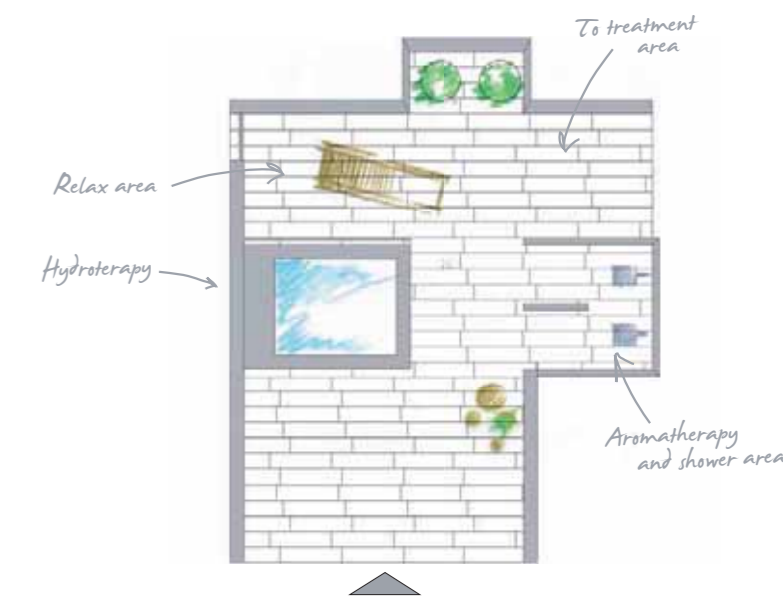

Sensazioni di naturale benessere

La sofisticata essenza Noce, con le sue lunghe vene ondulate e i nodi morbidi, ricrea un ambiente accogliente e suggestivo dove rigenerarsi con un piacevole effetto “cocooning”. Il connubio tra la naturalezza del legno e la tecnologia della ceramica rende Etic una finitura ideale per progetti dedicati all'accoglienza e al benessere, e in tutti i contesti in cui si richiedono prestazioni di praticità e sicurezza.

Les sensations d'un bien-être naturel

Avec son long veinage ondulé et la douceur de ses nœuds, Noce est une essence sophistiquée permettant de composer un espace accueillant et suggestif où un agréable effet « cocooning » permet de se retremper. Le mariage entre le naturel du bois et la technologie de la céramique font d'Etic la finition idéale dans les projets dédiés à l'accueil et au bien-être, ainsi que dans tous les contextes qui exigent des rendements de praticité et de sécurité.

Empfindungen natürlichen Wohlbefindens

Die raffinierte Essenz Noce mit ihren langen geschwungenen Äderungen und den weichen Knoten schafft ein behagliches und stimmungsvolles Ambiente, in dem man sich nur zu gerne dem angenehmen regenerierenden Effekt des “cocooning” hingeben möchte. Die Verbindung der Natürlichkeit des Holzes und der Technologie der Keramik macht Etic zum idealen Finish für Projekte im Empfangsbereich und des Wohlbefindens und überhaupt in allen Kontexten, in denen Leistungen wie Zweckmäßigkeit und Sicherheit gefragt sind.

Natural sensations of well-being

The sophisticated essence of Noce, with its long waving veining and soft knots, recreates a welcoming and evocative space in which to experience a regenerating “cocooning” effect. The merger between the naturalness of wood and technology of ceramics makes Etic the perfect finishing touch for projects dedicated to welcoming and wellness, and in every context where functionality and safety are required.

Sensaciones de bienestar natural

La sofisticada madera Noce, con sus largas venas onduladas y los nudos suaves, recrea un ambiente acogedor y suggestivo en donde regenerarse con un placentero efecto “cocooning”. La unión entre la naturaleza de la madera y la tecnología de la cerámica hace de Etic un acabado ideal para proyectos dedicados a la acogida y al bienestar, y para todos los contextos en los que es necesaria la practicidad y la seguridad.

Ощущение натуральности и комфорта

Изысканная ореховая фактура Noce своими длинными волнистыми прожилками и мягкими узелками рождает уютную атмосферу, в которой так приятно нежиться. А симбиоз натурального вида дерева и прочности керамогранита делают коллекцию идеальной для оформления курортных интерьеров, велнес-пространств и всех тех контекстов, где требуются практичные материалы с высокими показателями безопасности.

Spa&Beauty Club, London

Etic Essences: Noce 22,5x90, Noce Strutturato 22,5x90, Noce Tatami 22,5x90

Matching Surfaces: Advance Bianco Brera 45x90

Floor installation: Straightforward installation

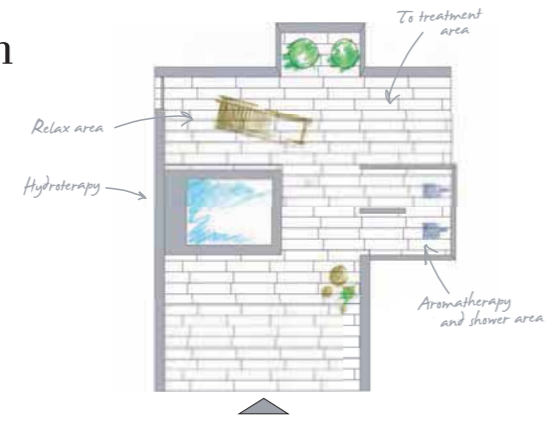

Spa&Beauty Club, London

Etic Essences: Noce 22,5x90, Noce Strutturato 22,5x90, Noce Tatami 22,5x90

Matching Surfaces: Advance Bianco Brera 45x90

Floor installation: Straightforward installation

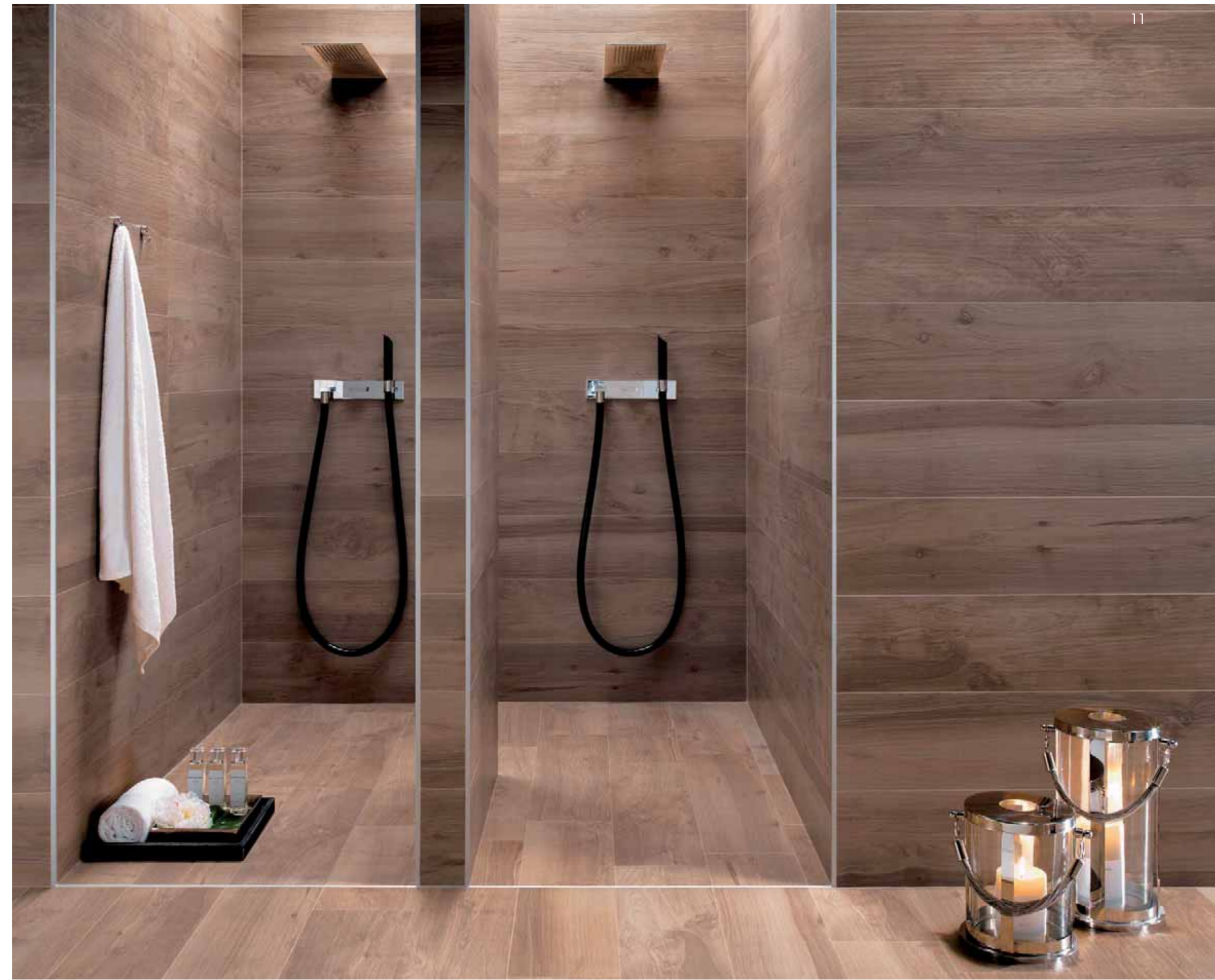
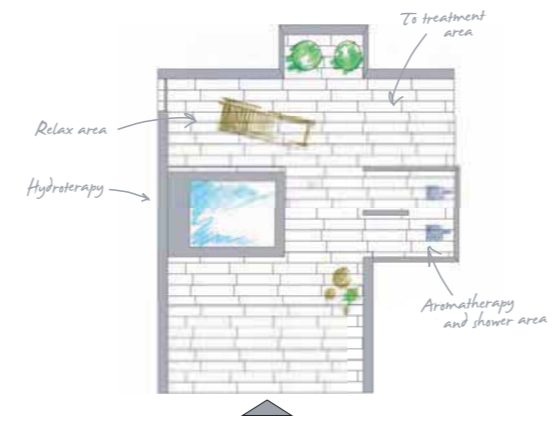



Hotel suite, Madrid

Etic Essences: Ebano 22,5x90

Matching Surfaces: Advance Bianco Brera 45x90,
Advance Bianco Brera Mosaico 30x30

Floor installation: Straightforward installation

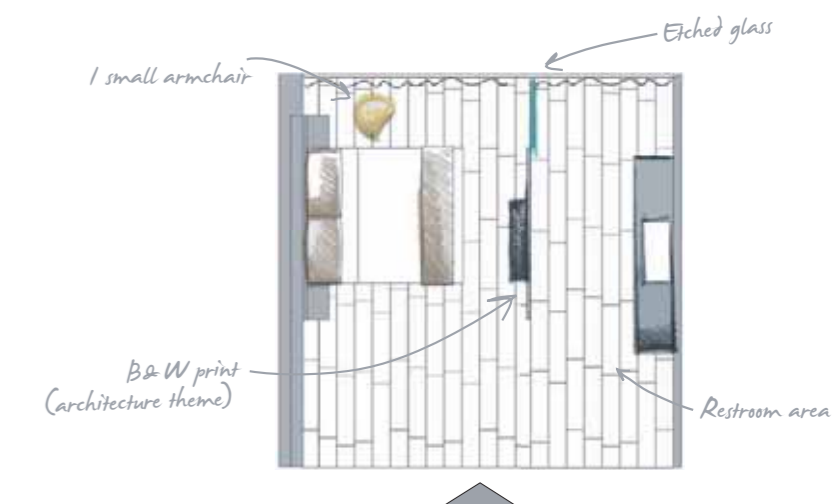

Natura che incanta e accoglie

Negli ambienti dedicati all'ospitalità, Etic esprime un'estetica suggestiva e accogliente enfatizzata dalle sensazioni evocate dall'Ebano, finitura che riproduce fedelmente il carattere magnetico del legno africano, contraddistinto da un colore intenso, solcato da lunghe venature e nodi decisi. Le sue tinte profonde si sposano con materie chiare e luminose in un gioco di chiaro scuro tutto naturale.

La nature enchante et accueille

Dans les espaces consacrés à l'hospitalité, Etic exprime une beauté suggestive et accueillante, soulignée par les sensations que dégage Ebano, une finition qui reproduit fidèlement le magnétisme d'une essence africaine caractérisée par sa couleur intense, ses longues veines et ses nœuds résolus. Ses teintes profondes se marient aux matières claires et lumineuses dans un jeu naturel d'ombres et de lumière.

Natur, die verzaubert und einhüllt

In Ambienten, die dem Gastgewerbe gewidmet sind, weist Etic eine bezaubernde und einnehmende Ästhetik auf und betont Gefühle und Eindrücke, die durch Ebano hervorgerufen werden. Das Finish, welches naturgetreu den anziehenden Charakter von afrikanischem Holz wiedergibt, charakterisiert auch durch die intensive Farbe, ist gekennzeichnet durch lange Äderungen und deutliche Knoten. Die beiden Töne verbinden sich in einem ganz natürlichen Spiel von Hell und Dunkel hervorragend mit klaren und hellen Materien.

Nature that enchants and welcomes

Used in hospitality venues, Etic expresses a suggestive and welcoming atmosphere via the sensations evoked by Ebano, a faithful reproduction of the charming attraction of African wood, renowned for its rich colour crossed by long veining and distinct knots. Its intense tints combine with brilliant and luminous materials in a natural play of bright and dark light.

Naturaleza que encanta y acoge

En los ambientes dedicados a la hospitalidad, Etic es la expresión de una estética suggestiva y acogedora enfatizada por las sensaciones evocadas por el Ebano, acabado que reproduce fielmente el fascinante carácter de esta madera africana, que se distingue por un color intenso, surcado por largas vetas y nudos marcados. Sus tonalidades profundas se combinan bien con materiales claros y luminosos en un juego de claroscuro totalmente natural.

Чарующая и радушная природа

В интерьерах отельных комплексов изысканная и радушная обстановка, создаваемая коллекцией Etic, подчёркивается эффектной фактурой Ebano, точно воспроизводящей чарующий вид африканского эбенового дерева с его насыщенными цветами, длинными прожилками и ярко выраженными узлами. Тёмные глубокие оттенки соседствуют в гармоничном контрасте со светлыми, даря пленительное ощущение натуральности.

Hotel suite, Madrid

Etic Essences: Ebano 22,5x90
 Matching Surfaces: Advance Bianco Brera 45x90,
 Advance Bianco Brera Mosaico 30x30
 Floor installation: Straightforward installation

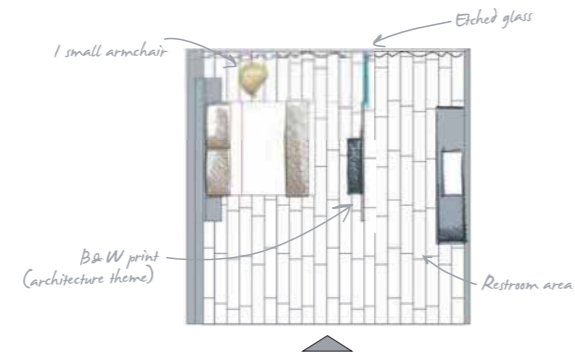

■ Hotel suite, Madrid

Etic Essences: Ebano 22,5x90
Matching Surfaces: Advance Bianco Brera 45x90,
Advance Bianco Brera Mosaico 30x30
Floor installation: Straightforward installation

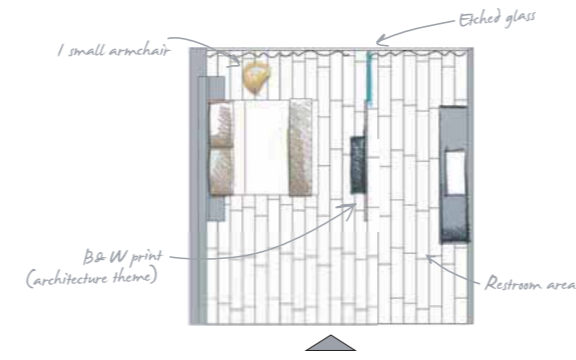



Art Cafè, Basel

Etic Essences: Rovere Grigio 22,5x90

Matching Surfaces: Plenitude White Orchid 30,5x91,5

Floor installation: Straightforward installation

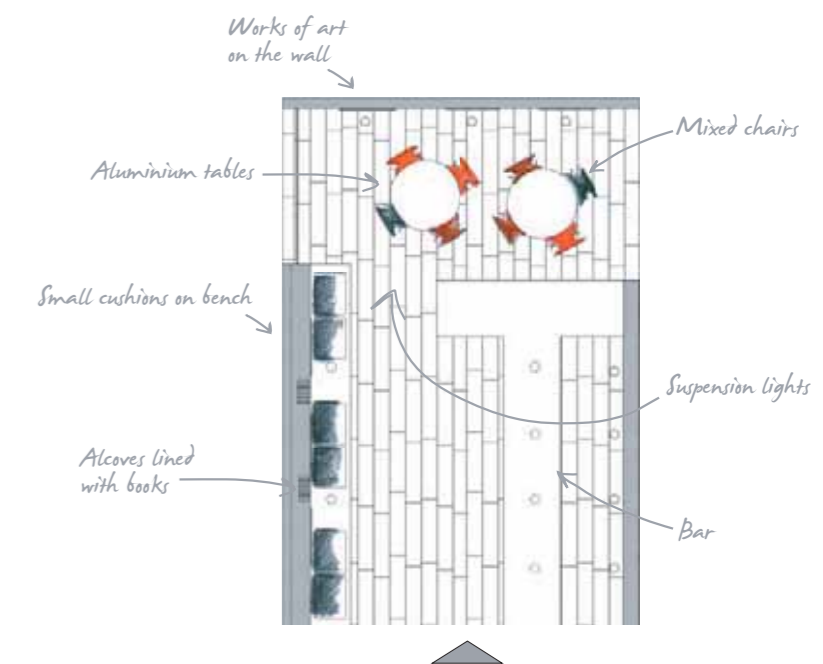

Architettura come opere d'arte

Gli spazi architettonici più attuali e di tendenza riscoprono il valore intramontabile del Rovere Grigio, ispirato a un'essenza che deve il suo fascino a un processo di invecchiamento naturale, che le dona una cromia inconfondibile ricca di suggestioni. Il formato delle doghe 22,5x90, posato a correre in un progetto coordinato a pavimento e rivestimento, crea un ambiente accogliente ricco di stile e personalità.

L'architecture est une œuvre d'art

En architecture, les espaces de tendance les plus actuels redécouvrent la valeur inaltérable de Rovere Grigio, inspiré d'une essence qui doit son charme au processus de vieillissement naturel qui lui donne une couleur incomparable, richement suggestive. Posées en longueur dans un projet coordonné au sol et aux murs, les lattes de format 22,50x90 composent un espace accueillant, riche de style et de personnalité.

Architektur als Kunstwerk

Die aktuellsten und trendigsten architektonischen Räume entdecken den zeitlosen Wert von Rovere Grigio wieder, inspiriert durch eine Holzessenz, die ihren Charme einem natürlichen Alterungsprozesses mit einer unverwechselbaren Farbgebung verdankt, reich an Empfindungen und Eindrücken. Das Format der Dielen 22,50x90, fortlaufend in einem aufeinander abgestimmten Projekt für Böden und Wände verlegt, erzeugt ein gemütliches Ambiente, stilvoll und voller Persönlichkeit.

Architecture as a piece of art

The most up-to-date and trend-setting architectural spaces rediscover the enduring value of Rovere Grigio, inspired by an essence that owes its fascination to a natural ageing process that enriches it with an unmistakable, emotional hue. The 22.5x90 size wood listels, with a straightforward installation in a coordinated project of floor and wall covering, creates a welcoming ambience rich in style and personality.

Arquitecturas como obras de arte

Los espacios arquitectónicos más actuales y de tendencia redescubren el valor imperecedero del Rovere Grigio, inspirado en una madera que debe su encanto a un proceso de envejecimiento natural, que le da una tonalidad inconfundible rica de sugerencias. El formato de las tablas 22,50x90, con colocación simple en un proyecto coordinado de pavimento y revestimiento, crea un ambiente acogedor rico de estilo y personalidad.

Архитектурные формы как произведения искусства

Современные архитектурные формы, облачаясь в тон Rovere Grigio, снова открывают для себя непреходящее благородство дубового дерева. Очаровательная фактура плиток напоминает естественно состарившуюся древесину дуба с её характерным, изысканным цветом. Уложенный вразбежку на полы и стены формат 22,50x90 придаёт интерьеру стильность и своеобразие, рождая при этом удивительно гостеприимную обстановку.

Art Cafè, Basel

Etic Essences: Rovere Grigio 22,5x90

Matching Surfaces: Plenitude White Orchid 30,5x91,5

Floor installation: Straightforward installation

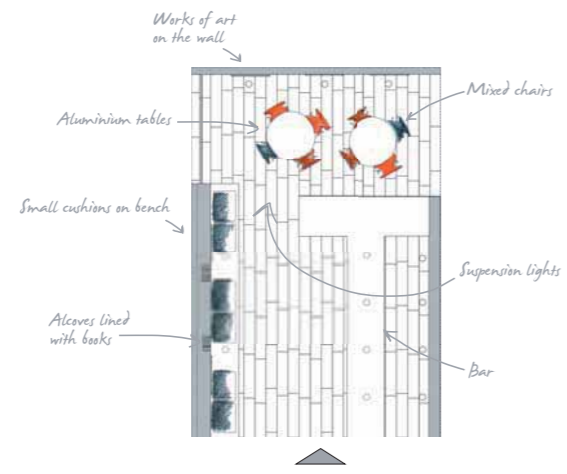

Art Cafè, Basel

Etic Essences: Rovere Grigio 22,5x90

Matching Surfaces: Plenitude White Orchid 30,5x91,5

Floor installation: Straightforward installation

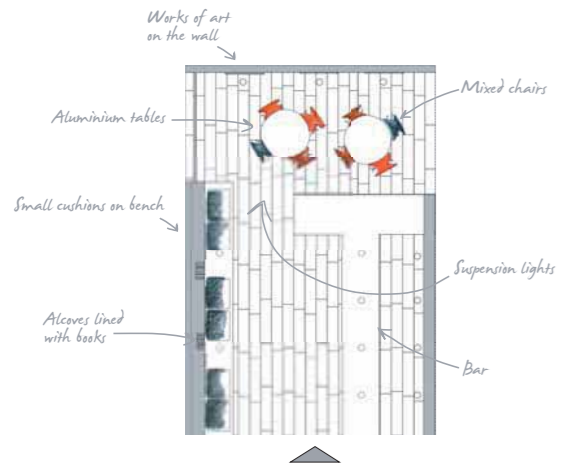



Floral showroom, Milan

Etic Essences: Palissandro 22,5x90 / 15x90, Palissandro Tatami 22,5x90

Matching Surfaces: Advance Moca Creme 45x90

Floor installation: Straightforward installation

Decorazioni di sofisticata essenzialità

Il carattere deciso del Palissandro, essenza esotica dalla tonalità bruna arricchita da striature scure, conferisce eleganza e fascino ad ambienti commerciali dal design raffinato. Etic propone tre diversi formati su base di 90 cm, che ripropongono le tipiche doghe del legno da pavimento e possono essere accostate tra loro in differenti giochi di posa. Elegante e versatile, il mosaico Tatami scompone in sottili listelli la grafica di superficie valorizzando quinte e pareti.

Des décorations d'une essentialité sophistiquée

Le caractère résolu de Palissandro, cette essence exotique aux tons bruns, enrichies de veinures foncées, donne de l'élégance et du charme aux espaces commerciaux d'un design raffiné. Etic propose trois formats différents de 90 cm de base qui reproduisent les lattes de bois traditionnellement utilisées pour les sols et peuvent se combiner entre elles en différents jeux de pose. Élégante et versatile, la mosaïque Tatami décompose le motif de la surface en fins listels qui rehaussent les murets et les murs.

Dekore von raffinierter Sachlichkeit

Der hervortretende Charakter von Palissandro, einer exotischen Essenz in bräunlicher Farbe, bereichert durch dunkle Streifen, verleiht Industrieambienzen in raffiniertem Design Eleganz und Charme. Etic ist, auf Basis von 90 cm Länge, in drei unterschiedlichen Breiten verfügbar, die den typischen Holzdielen für Fußböden nachempfunden sind und untereinander in verschiedenen Verlegearten verwendet werden können. Elegant und vielseitig bringt das Mosaik Tatami mit seinen dünnen Leisten die Grafik der Oberfläche durcheinander und betont dadurch Kulissen und Wände.

Decoraciones de sofisticada esencialidad

El carácter decidido del Palissandro, madera exótica estriada y de tonalidad oscura, confiere elegancia y encanto a ambientes comerciales de diseño refinado. Etic propone tres diferentes formatos sobre base de 90 cm, que reproducen las típicas tablas de madera para pavimento y pueden ser combinadas entre sí en diferentes juegos de colocación. Elegante y versátil, el mosaico Tatami descompone en sutiles listeles el diseño gráfico de superficie valorizando mamparas y paredes.

Изысканно-строгие декоры

Решительный характер фактуры палисандровое дерево с его светло-коричневым фоновым цветом и узором из темных прожилок, придаёт коммерческим интерьерам пленительную элегантность. Etic предлагает три формата на основе модульной длины в 90 см: все они воспроизводят формы половых досок и могут сочетаться между собой в различных рисунках укладки. Элегантная, многофункциональная мозаика Tatami разлагает рисунок облицованной поверхности на тонкие бордюры, эффектно оттеняя нарядность стен и перегородок.

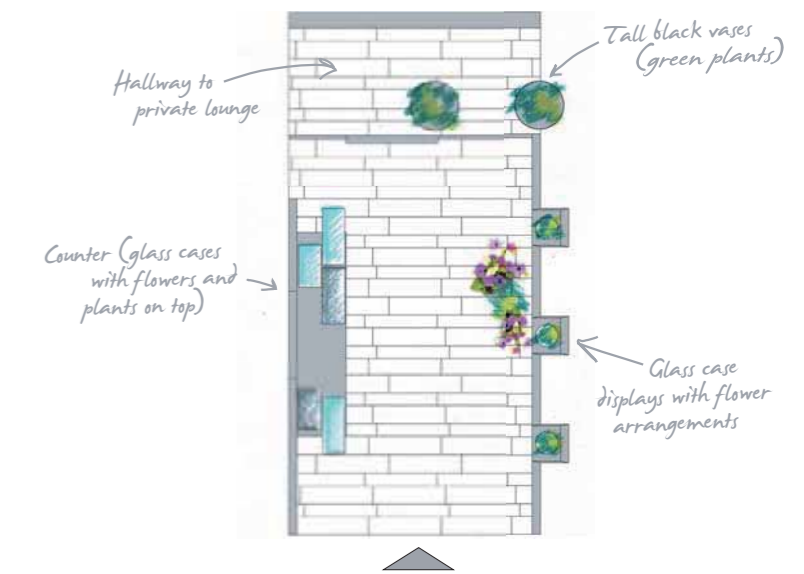

Decorations of sophisticated essentiality

The bold character of Palissandro, an exotic essence with a brown shade enriched by dark streaks, bestows elegance and charm to commercial spaces of refined design. Etic features three different sizes, all with a 90 cm length, which reproduce the listels characteristic of parquet wood for flooring and may be played off against each other through different installation patterns. Sophisticated and versatile, the Tatami mosaic thin listels break down the graphic look of its surface, enhancing panel partitioning and walls.

Floral showroom, Milan

Etic Essences: Palissandro 22,5x90 / 15x90,
Palissandro Tatami 22,5x90
Matching Surfaces: Advance Moca Creme 45x90
Floor installation: Straightforward installation

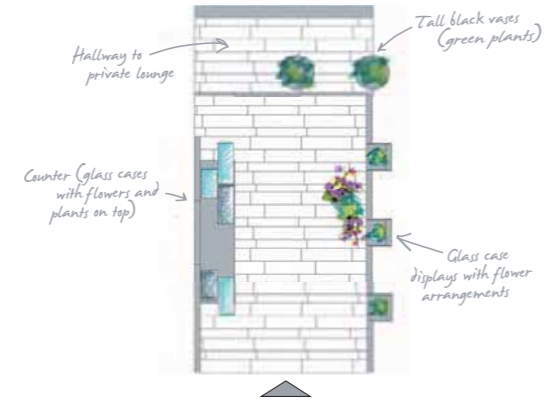



Floral showroom, Milan

Etic Essences: Palissandro 22,5x90 / 15x90,
 Palissandro Tatami 22,5x90
 Matching Surfaces: Advance Moca Creme 45x90
 Floor installation: Straightforward installation

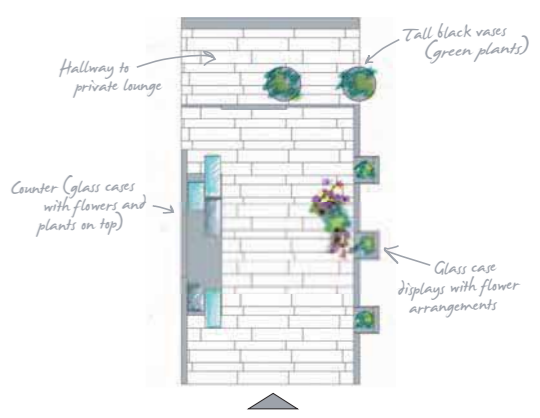

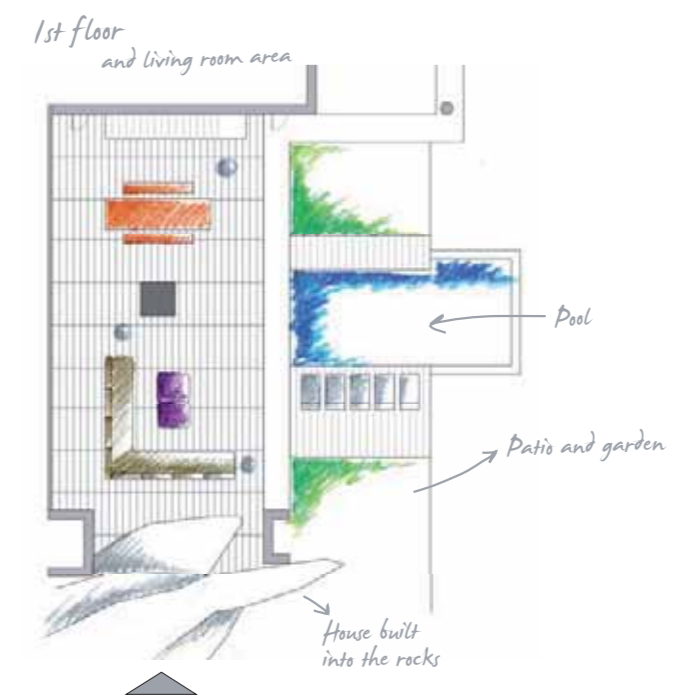

■ Private villa, Perth

Etic Essences: Rovere Bianco 22,5x90, Rovere Bianco Strutturato 22,5x90
 Rovere Bianco Elemento L Strutturato 22,5x90,
 Noce 11x90, Noce Strutturato 22,5x90
 Floor installation: Linear installation

Applicazioni ad elevate prestazioni

Il candore naturale del Rovere Bianco conferisce agli ambienti essenzialità e luce negli spazi interni come negli esterni, dove la superficie strutturata si completa con l'elemento L, indispensabile per rifinire gradini e bordi piscina. Etic porta il fascino del legno nei contesti preclusi alla materia naturale, grazie a elevate performance tecniche.

Top performance applications

The natural whiteness of Rovere Bianco gives spaces an essential and soft touch, both indoors and outdoors, where the textured surface is completed by the L element, a prerequisite for finishing off steps and swimming-pool edges. Etic brings the glamour of wood into those contexts that are traditionally shut off from natural materials, thanks to its high technical features.

Private Villa, Perth

Etic Essences: Rovere Bianco 22,5x90, Rovere Bianco Strutturato 22,5x90
Rovere Bianco Elemento L Strutturato 22,5x90
Floor installation: Linear installation

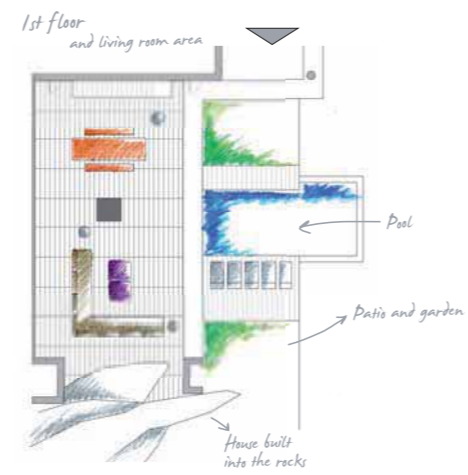



Private Villa, Perth

Etic Essences: Rovere Bianco Strutturato 22,5x90, Rovere Bianco Elemento L Strutturato 22,5x90
Floor installation: Linear installation

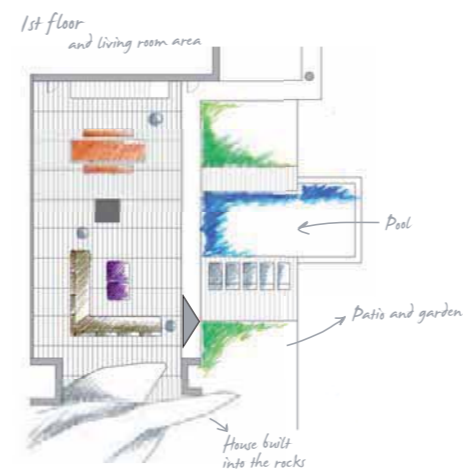

Applications aux performances élevées.

La blancheur naturelle de Rovere Bianco apporte aux espaces de l'essentialité et de la lumière, tant à l'intérieur qu'à l'extérieur où la surface structurée est complétée par une élément en L, indispensable aux finitions des escaliers et des bords de piscine. Grâce à ses rendements techniques élevés, Etic apporte le charme du bois dans les contextes interdits aux matériaux naturels.

Hohe Leistungen.

Die natürliche Reinheit von Rovere Bianco verleiht den Ambienten, innen wie außen, Sachlichkeit und Licht, wobei die Oberfläche strukturierte das Angebot mit dem L-Element, unentbehrlich für Treppen und Schwimmbadränder, vervollständigt. Etic trägt den Charme des Holzes in Kontexte, die natürlichen Materialien verwehrt sind und besticht durch die technische Leistung.

Aplicaciones de elevadas prestaciones.

El candor natural del Rovere Bianco confiere a los ambientes esencialidad y luz tanto en los espacios interiores como en los exteriores, donde la superficie estructurada se completa con el elemento L, indispensable para acabar escalones y bordes de piscina. Etic lleva el encanto de la madera a los contextos en los que está excluido el empleo de la materia natural, gracias a sus elevadas características técnicas.

Высокие эксплуатационные качества.

Натуральная, мягкая чистота дубовой фактуры Rovere Bianco придаёт интерьерам и экстерьерам благородную строгость и вместе с тем наполняет их тёплым светом. Для укладки на улице плитки со структурной поверхностью дополняются L-образными элементами, дающими возможность красиво оформить ступени и края бассейнов. Etic приносит с собой очарование древесного рисунка даже в те контексты, в которых применение самого дерева невозможно, обеспечивая при этом высочайшие эксплуатационные показатели.



Private Villa, Perth

Etic Essences: Rovere Bianco 22,5x90, Rovere Bianco Strutturato 22,5x90
Floor installation: Linear installation

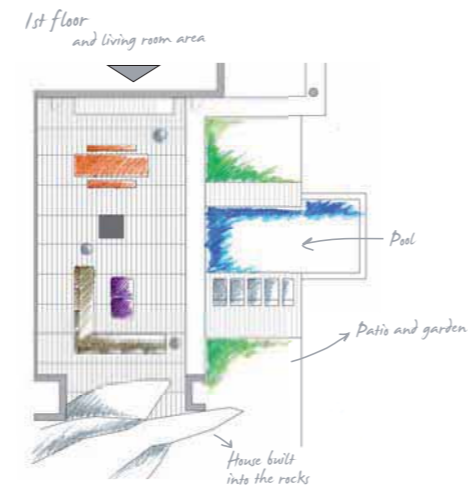

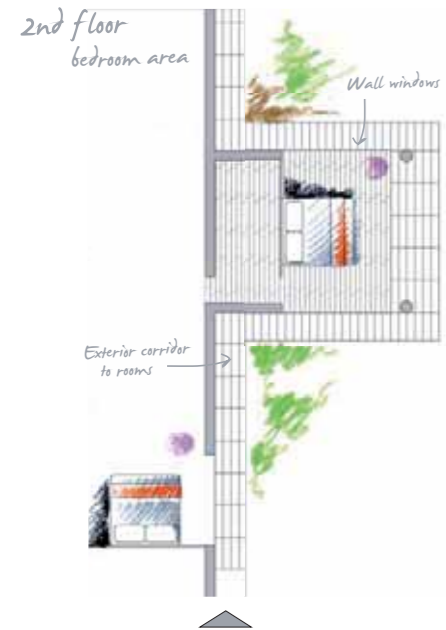

Private Villa, Perth

Etic Essences: Noce 11x90, Noce Strutturato 22,5x90

Floor installation: Straightforward installation

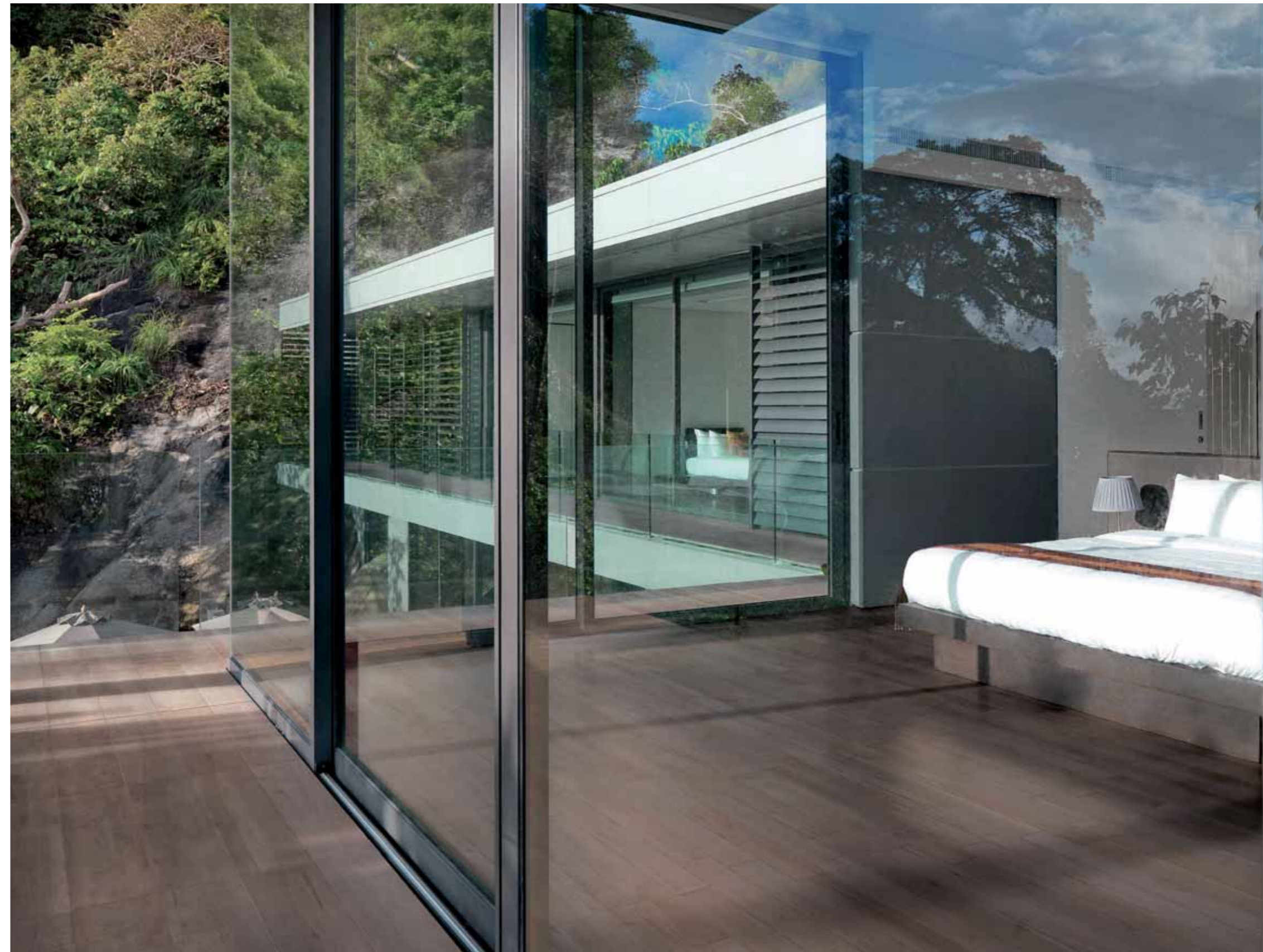

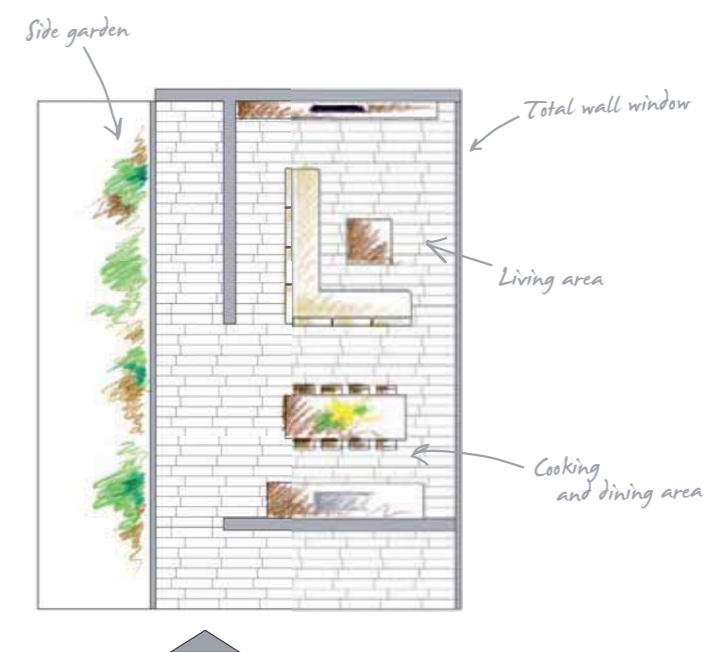

■ Seaside house, Rodi

Etic Essences: Rovere 15x90, Rovere Strutturato 22,5x90

Floor installation: Straightforward installation

Esterni ed interni in **continuità**

La discreta luminosità del Rovere, la più classica delle essenze da pavimento, si rivela una perfetta finitura d'arredo negli spazi residenziali in cui la luce naturale diventa parte essenziale del contesto architettonico. Le due finiture superficiali, matt e strutturata consentono di realizzare progetti coordinati senza soluzione di continuità tra dentro e fuori.

Continuity between outdoors and indoors

The soft luminosity of Rovere, the most classic wood essence for floors, proclaims itself as the perfect decoration finishing for residential spaces where natural light becomes an essential part of architecture environment. The two surfaces finishes, matt and textured, allow for co-ordinated projects with a continuous effect on indoor and outdoor surfaces.



■ Seaside house, Rodi

Etic Essences: Rovere 15x90, Rovere Strutturato 22,5x90
 Floor installation: Straightforward installation





■ Seaside house, Rodi

Etic Essences: Rovere 15x90,
 Rovere Strutturato 22,5x90
 Floor installation: Straightforward installation

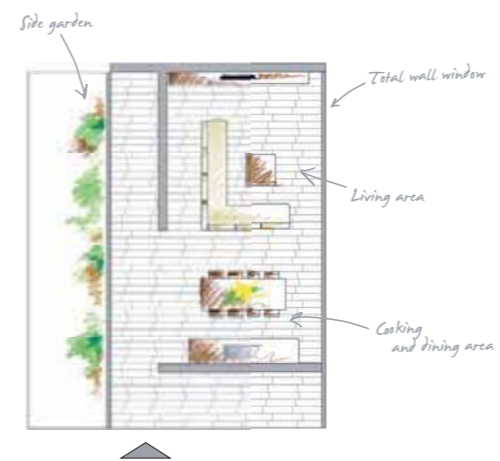

La continuité entre extérieur et intérieur.

La luminosité discrète de Rovere, la plus classique des essences de plancher, se révèle une finition parfaite pour décorer les espaces résidentiels où la lumière naturelle devient une partie essentielle du contexte architectural. mate, douce et raffinée, ou structurée avec des qualités techniques excellentes, les deux finitions de surface permettent de concrétiser des projets coordonnés sans raccord entre intérieur et extérieur.

Außen – und Innenbereiche in Kontinuität.

Die diffuse Leuchtkraft von Rovere die klassischste unter den Bodenessenzen, entpuppt sich als perfektes Einrichtungsfinish für Wohnräume, in denen natürliches Licht zu einem wesentlichen Bestandteil des architektonischen Kontextes wird. Die beiden Oberflächenfinishes matt und strukturiert erlauben die Realisierung von aufeinander abgestimmten Projekten ohne die Kontinuität zwischen Innen und Außen aufzulösen.

Exteriores e interiores con continuidad.

La luminosidad tenue del Rovere, la más clásica de las maderas de pavimento, se revela un perfecto acabado de decoración en los espacios residenciales en que la luz natural se vuelve parte esencial del contexto arquitectónico. Los dos acabados superficiales, mate y estructurado permiten realizar proyectos coordinados sin separaciones entre los interiores y exteriores.

Интерьеры и экстерьеры как цельное единство.

Умеренная яркость фактуры Rovere, воспроизводящей вид наиболее традиционной для устройства полов дубовой древесины, идеальна для оформления домашних контекстов, в которых натуральному свету отводится роль существенного элемента дизайна. Два варианта поверхности, матовый и структурный, дают возможность гармонично оформить интерьеры и экстерьеры в едином стиле.

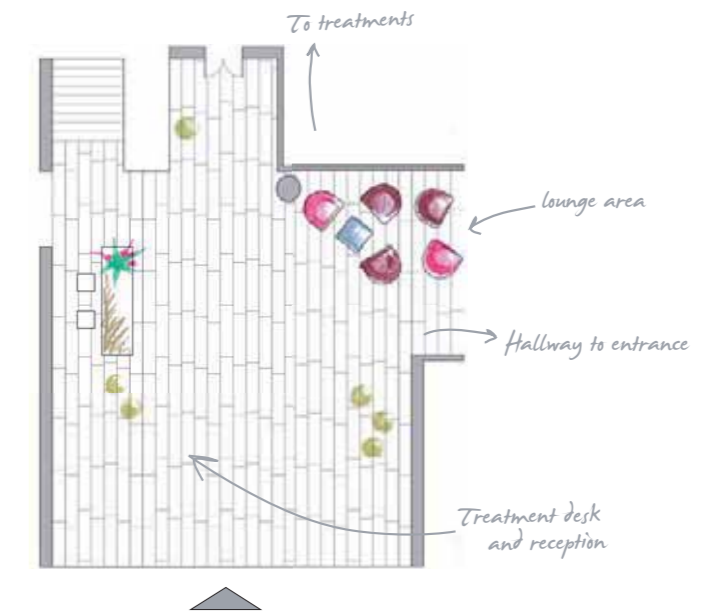

■ Golf Resort, Tuscany

Etic Essences: Ulivo 22,5x90 / 15x90, Ulivo Tatami 22,5x90

Floor installation: Straightforward installation

Sensazioni di autenticità e valore

Valore autentico, suggestione naturale, profumo mediterraneo: sono le emozioni che evoca l'Ulivo, legno pregiato dalla cromia insolita e seducente e dal marcato contrasto di nodi e vene, che la superficie ceramica riproduce con assoluta fedeltà, assicurando qualità tecniche eccellenti. Il mosaico Tatami diventa preziosa finitura d'arredo per rivestire con stile i volumi architettonici.

Sensations of genuineness and value

Authentic value, natural suggestions, Mediterranean scent: all emotions evoked by the Ulivo, a valued wood with an unprecedented and seductive hue and bold contrast of knots and veining, faithfully reproduced on the ceramic surface ensuring excellent technical qualities at the same time. The mosaic Tatami becomes a precious furnishing element to clad with style architectural projects.



■ Golf Resort, Tuscany

Etic Essences: Ulivo 22,5x90 / 15x90, Ulivo Tatami 22,5x90
 Floor installation: Straightforward installation

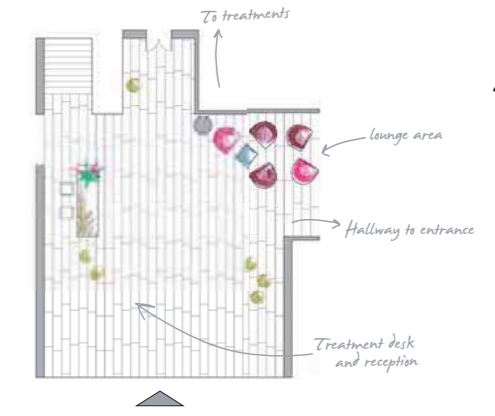



Des sensations d'authenticité et de valeur.

Une valeur authentique, une suggestion naturelle, le parfum de la Méditerranée : ce sont les émotions suscitées par Ulivo, une essence précieuse d'une couleur insolite et séduisante, avec des veines et des nœuds bien marqués que la surface de la céramique reproduit avec une fidélité absolue tout en garantissant d'excellentes qualités techniques. La mosaïque Tatami devient une finition de décoration précieuse pour habiller avec style les volumes d'architecture.

Eindrücke von Authentizität und Wert.

Authentische Werte, natürlicher Reiz, mediterraner Touch: das sind Eindrücke, die Ulivo hervorruft. Ein hochwertiges Holz von ungewöhnlicher und verführerischer Farbe mit ausgeprägtem Kontrast der Knoten und Äderungen, das von der keramische Oberfläche äußerst naturgetreu reproduziert wird und die gleichzeitig hervorragende technische Eigenschaften gewährleistet. Das Mosaik Tatami wird zum kostbaren Einrichtungsfinish, um architektonische Räume zu gestalten.

Sensaciones de autenticidad y valor.

Valor auténtico, sugestión natural, perfume mediterráneo: son las emociones que evoca Ulivo, madera preciada de tonalidad insólita y seductora y de un marcado contraste de nudos y venas que la superficie cerámica reproduce con absoluta fidelidad, garantizando características técnicas excelentes. El mosaico Tatami se convierte en precioso acabado de decoración para revestir con estilo los volúmenes arquitectónicos.

Ощущение подлинной ценности.

Подлинная ценность, натуральное очарование, средиземноморский аромат – вот ощущения, которые вызывает Ulivo, фактура, преданно воспроизводящая изумительный цвет и ярко выраженный контраст узлов и прожилок оливкового дерева. Великолепная эстетика плиток дополняется превосходными техническими характеристиками. Мозаика Tatami становится ценным элементом финальной отделки, придающим архитектурным объемам особую стильность.

■ Golf Resort, Tuscany

Etic Essences: Ulivo 22,5x90 / 15x90,

Ulivo Tatami 22,5x90

Floor installation: Straightforward installation

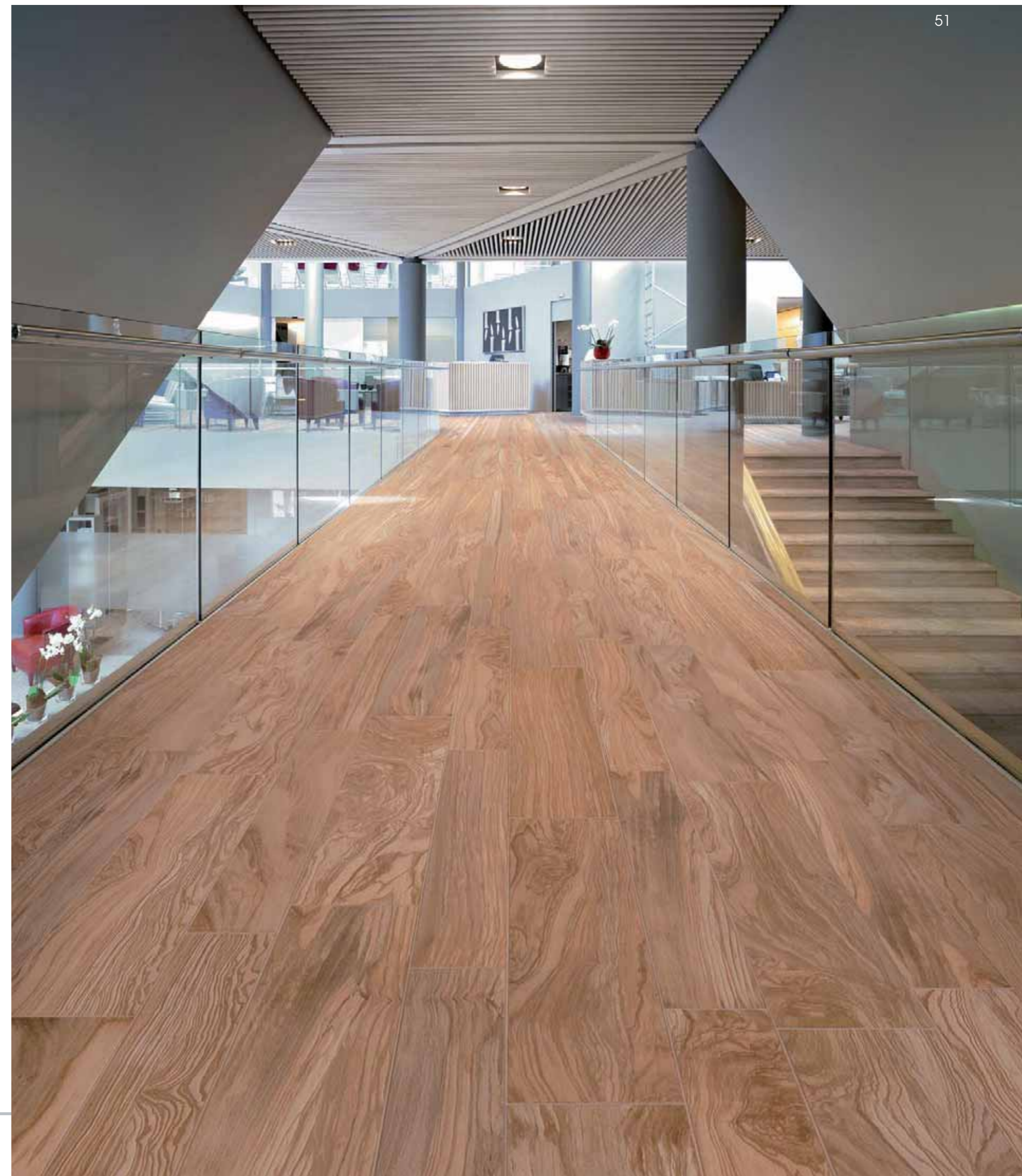
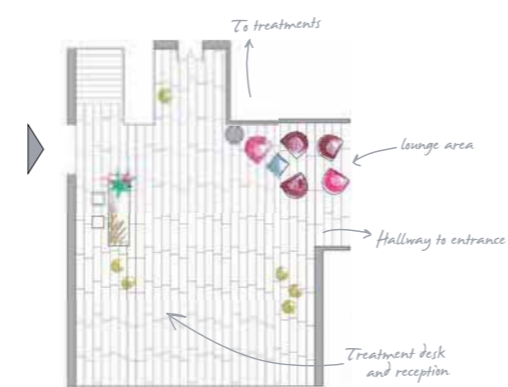

Rovere



Etic Rovere
 22,5x90 Rettificato
 22,5x90 cm - 9"x36"



Etic Rovere
 15x90 Rettificato
 15x90 cm - 6"x36"



Etic Rovere
 11x90 Rettificato
 11x90 cm - 4.4"x36"

Ulivo



Etic Ulivo
 22,5x90 Rettificato
 22,5x90 cm - 9"x36"



Etic Ulivo
 15x90 Rettificato
 15x90 cm - 6"x36"



Etic Ulivo
 11x90 Rettificato
 11x90 cm - 4.4"x36"

Noce



Etic Noce
 22,5x90 Rettificato
 22,5x90 cm - 9"x36"



Etic Noce
 15x90 Rettificato
 15x90 cm - 6"x36"



Etic Noce
 11x90 Rettificato
 11x90 cm - 4.4"x36"

Palissandro



Etic Palissandro
 22,5x90 Rettificato
 22,5x90 cm - 9"x36"



Etic Palissandro
 15x90 Rettificato
 15x90 cm - 6"x36"



Etic Palissandro
 11x90 Rettificato
 11x90 cm - 4.4"x36"

Rovere Bianco



Etic Rovere Bianco
 22,5x90 Rettificato
 22,5x90 cm - 9"x36"



Etic Rovere Bianco
 15x90 Rettificato
 15x90 cm - 6"x36"



Etic Rovere Bianco
 11x90 Rettificato
 11x90 cm - 4.4"x36"

Rovere Grigio



Etic Rovere Grigio
 22,5x90 Rettificato
 22,5x90 cm - 9"x36"



Etic Rovere Grigio
 15x90 Rettificato
 15x90 cm - 6"x36"



Etic Rovere Grigio
 11x90 Rettificato
 11x90 cm - 4.4"x36"

Ebano



Etic Ebano
 22,5x90 Rettificato
 22,5x90 cm - 9"x36"



Etic Ebano
 15x90 Rettificato
 15x90 cm - 6"x36"



Etic Ebano
 11x90 Rettificato
 11x90 cm - 4.4"x36"



Rovere



Etic Rovere
22,5x90 Strutturato
22,5x90 cm - 9"x36"

Ulivo



Etic Ulivo
22,5x90 Strutturato
22,5x90 cm - 9"x36"

Noce



Etic Noce
22,5x90 Strutturato
22,5x90 cm - 9"x36"

Palissandro



Etic Palissandro
22,5x90 Strutturato
22,5x90 cm - 9"x36"

Rovere Bianco



Etic Rovere Bianco
22,5x90 Strutturato
22,5x90 cm - 9"x36"

Rovere Grigio



Etic Rovere Grigio
22,5x90 Strutturato
22,5x90 cm - 9"x36"

Ebano



Etic Ebano
22,5x90 Strutturato
22,5x90 cm - 9"x36"

Tatami



Etic Rovere
Tatami 22,5x90
22,5x90 cm - 9"x36"



Etic Ulivo
Tatami 22,5x90
22,5x90 cm - 9"x36"



Etic Noce
Tatami 22,5x90
22,5x90 cm - 9"x36"



Etic Palissandro
Tatami 22,5x90
22,5x90 cm - 9"x36"



Etic Rovere Bianco
Tatami 22,5x90
22,5x90 cm - 9"x36"



Etic Rovere Grigio
Tatami 22,5x90
22,5x90 cm - 9"x36"



Etic Ebano
Tatami 22,5x90
22,5x90 cm - 9"x36"

Cassettone



Etic Rovere Cassettone 45 - 45x45 cm - 18"x18"



Etic Rovere Bianco Cassettone 45 - 45x45 cm - 18"x18"



Etic Ulivo Cassettone 45 - 45x45 cm - 18"x18"



Etic Noce Cassettone 45 - 45x45 cm - 18"x18"



Etic Rovere Grigio Cassettone 45 - 45x45 cm - 18"x18"



Etic Palissandro Cassettone 45 - 45x45 cm - 18"x18"



Etic Ebano Cassettone 45 - 45x45 cm - 18"x18"



Etic Bottone

7x7 cm - 2.8"x2.8"



Etic Rovere Bottone 7x7



Etic Noce Bottone 7x7



Etic Palissandro Bottone 7x7



Etic Ulivo Bottone 7x7



Etic Rovere Bianco Bottone 7x7



Etic Rovere Grigio Bottone 7x7



Etic Ebano Bottone 7x7

Advance Bottone

7x7 cm - 2.8"x2.8"



Bianco Brera Bottone 7x7



Moca Creme Bottone 7x7



Dorato Aral Bottone 7x7



Grigio Lipica Bottone 7x7



Nero Basalto Bottone 7x7

Cassettone - Abbinamenti Consigliati / Recommended Combinations

Bottone	Rovere	Ulivo	Noce	Palissandro	Rovere Bianco	Rovere Grigio	Ebano
---------	--------	-------	------	-------------	---------------	---------------	-------

Etic

Rovere				•			•
Ulivo				•			•
Noce				•	•		•
Palissandro	•		•		•		
Rovere Bianco	•			•		•	•
Rovere Grigio					•		
Ebano	•	•	•	•	•	•	

Advance

Bianco Brera			•	•		•	•
Moca Creme			•	•			
Dorato Aral	•		•	•		•	•
Grigio Lipica					•		•
Nero Basalto		•		•	•		

Pezzi speciali / Trim tiles

Pièces spéciales / Spezialstücke / Piezas especiales / Специальные элементы

INDOOR TRIM TILES

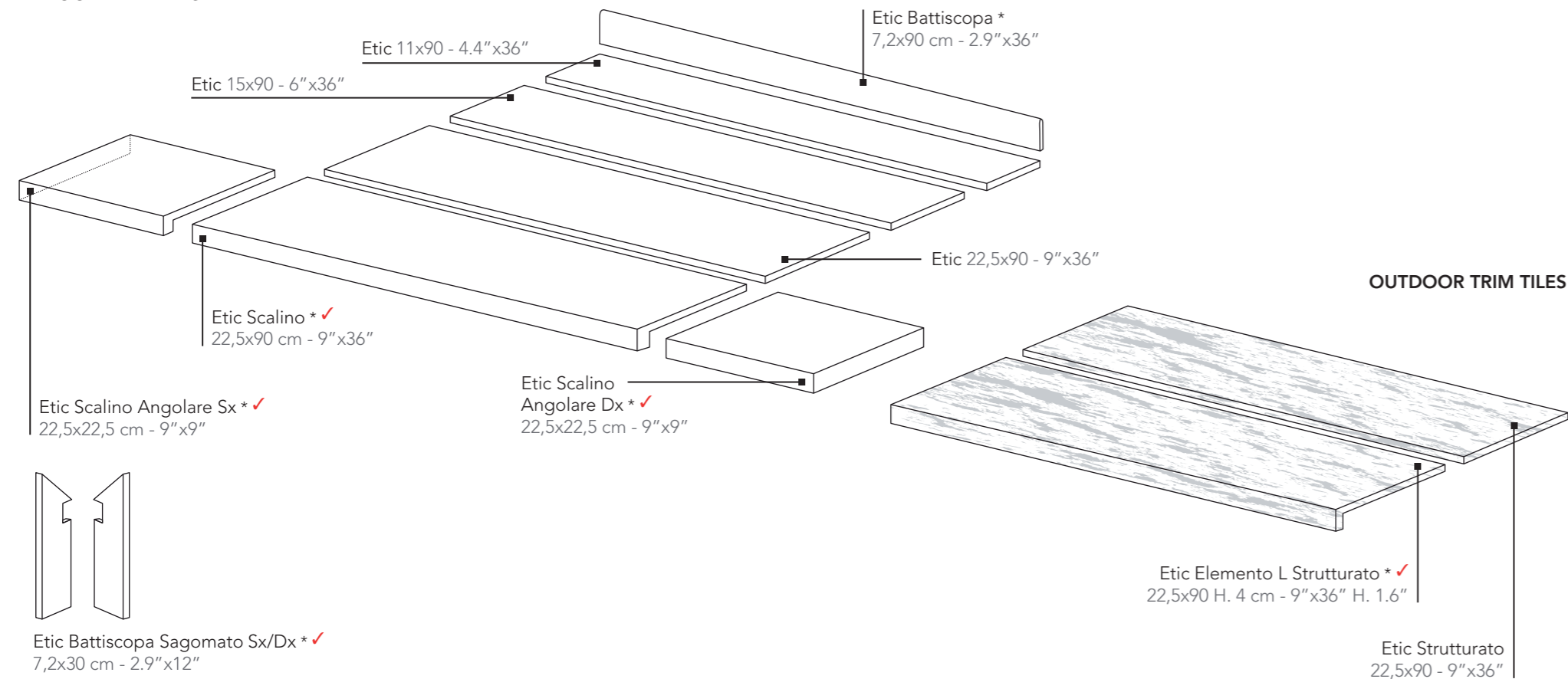

OUTDOOR TRIM TILES

* Disponibile in tutti i colori / Available in all colours
 Disponible dans toutes les couleurs / In allen Farben Verfügbar
 Disponibles en todos los colores / Имеются все цвета

✓ I pezzi sono disponibili su ordinazione / These parts are supplied to order
 Les pièces sont disponibles sur commande / Die Teile sind auf Bestellung lieferbar
 Las piezas se hacen por encargo / Изготавливаются на заказ

Note / Notes

Notes / Anmerkungen / Notas / Примечания

Per le informazioni e i dati relativi a codici, imballaggi e pesi occorre sempre consultare l'ultimo listino aggiornato e in vigore / For information and details relating to codes, packaging and weight it is recommended to refer to the latest pricelist / Pour toutes informations et renseignements concernant les codes, les emballages et les poids, il y a toujours lieu de consulter le dernier tarif en vigueur et mis à jour / Für Informationen und Daten die den Code, die Verpackung und das Gewicht betreffen bitte die aktuellste Preisliste zugrunde legen / Para acceder a la información y a los datos relativos a códigos, embalajes y pesos hay que consultar siempre la última lista de precios actualizada y vigente / Для информации о кодах, упаковках и весе обращайтесь к последнему действующему прайс-листу.

I colori e le caratteristiche estetiche dei materiali illustrati nel presente catalogo sono da ritenersi puramente indicativi / Colours and optical features of the materials illustrated in this catalogue are to be regarded as mere indications / Les coloris et les caractéristiques esthétiques des références illustrées dans le catalogue sont donnés à titre purement indicatif / Die Farben und die ästhetischen Eigenschaften der in diesem Katalog abgebildeten Produkte sind als reine Richtwerte zu betrachten / Los colores y las características estéticas de los materiales ilustrados en el presente catálogo deben ser considerados como puramente indicativos / Цвета и эстетические характеристики описанных в настоящем каталоге материалов являются только ориентировочными.

Atlas Concorde si riserva di modificare i prodotti senza preavviso, declinando ogni responsabilità su eventuali danni diretti o indiretti derivanti da eventuali modifiche / Atlas Concorde reserves the right to modify any product without notice and will not be liable for any direct or indirect damage resulting from such modifications / Atlas Concorde se réserve le droit de modifier ses produits sans préavis et décline toute responsabilité concernant les éventuels dommages directs ou indirects qui pourraient dériver de ces modifications / Atlas Concorde behält sich das Recht vor jederzeit und ohne vorherige Ankündigung, die Produkte zu verändern, und lehnt jede Haftung bei direkten oder indirekten Schäden ab, die von diesen Veränderungen herrühren / Atlas Concorde se reserva el derecho de modificar los productos sin previo aviso, rechaza cualquier responsabilidad sobre eventuales daños directos o indirectos derivados de eventuales modificaciones / Atlas Concorde оставляет за собой право изменять характеристики изделий без предварительного уведомления, отклоняя при этом любую ответственность за прямые или косвенные убытки, возникшие в результате изменений.

Si ringrazia la galleria Betta Frigieri Arte Contemporanea per la gentile concessione delle opere dell'ambiente Art Café / Special thanks to the Betta Frigieri Gallery of Contemporary Art for the Art Café paintings / Nous remercions la galerie Betta Frigieri Arte Contemporanea qui nous a gentiment prêté les œuvres de l'espace Art Café / Wir danken der Galerie Betta Frigieri Arte Contemporanea (Zeitgenössische Kunst) für die freundliche Zurverfügungstellung der Kunstwerke im Ambiente Art Café / Agradecemos especialmente a Betta Frigieri Arte Contemporanea por la gentil concesión de las obras del ambiente Art Café / Авторы выражают благодарность галереи Betta Frigieri Arte Contemporanea за предоставление произведений интерьера Арт-кафе.

www.associazioneculturalebettafrigieri.it

Suggerimenti e alternative di posa / Installation tips

Conseils et calepinages divers / Empfehlungen und Verlegealternativen / Sugerencias y alternativas de colocación / Рекомендации и варианты укладки

Per la collezione Etic, Atlas Concorde consiglia la posa a correre con listoni sfalsati di massimo 35 cm e fuga di 1-2 mm. Per la posa in esterno si consiglia la posa con fuga di 3 mm. / For Etic collection, Atlas Concorde recommends a straightforward installation pattern with staggered listels of maximum 35cm and a grout line of 1-2mm. For outdoor application, we recommend allowing 3mm grout line. / Pour la collection Etic, Atlas Concorde conseille la pose longitudinale avec un décalage maximum de 35 cm et des joints de 1-2 mm. Pour une pose en extérieur, les joints conseillés sont de 3 mm. / Für die Kollektion Etic empfiehlt Atlas Concorde eine versetzte Verlegung von max. 35 cm und eine Fuge von 1-2 mm. Bei der Verlegung in Außenbereichen wird zu einer Fuge von 3 mm geraten. / Para la colección Etic, Atlas Concorde aconseja la colocación simple con listones con un desfase máximo de 35 cm y una junta de 1-2 mm. Para la colocación en exteriores se aconseja la junta de 3 mm. / Atlas Concorde рекомендует укладывать плитки коллекции Etic вразбежку с максимальным смещением в 35 см и со швом шириной 1-2 мм. При укладке в наружных условиях рекомендуется шов шириной 3 мм.

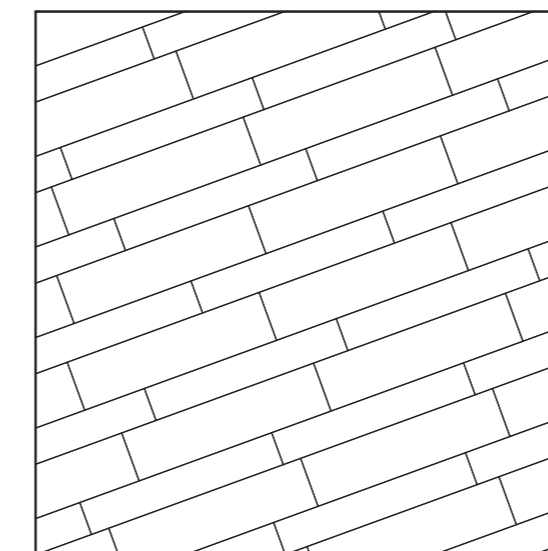
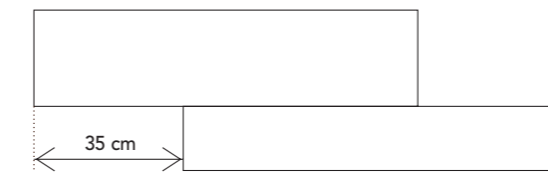

22,5x90 cm / 9"x36" (60%)
 15x90 cm / 6"x36" (40%)

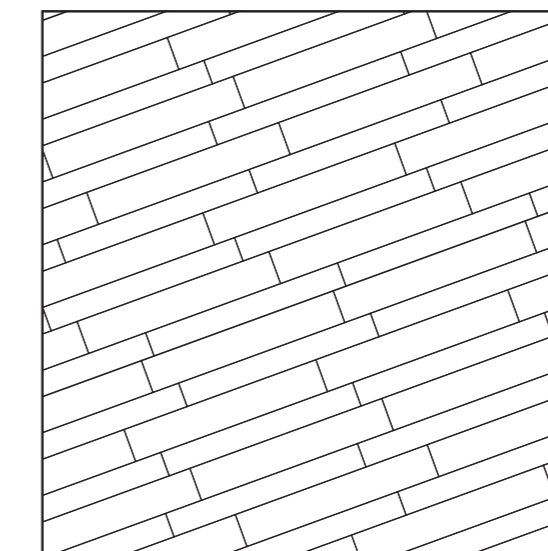

15x90 cm / 6"x36" (57,7%)
 11x90 cm / 4.4"x36" (42,3%)

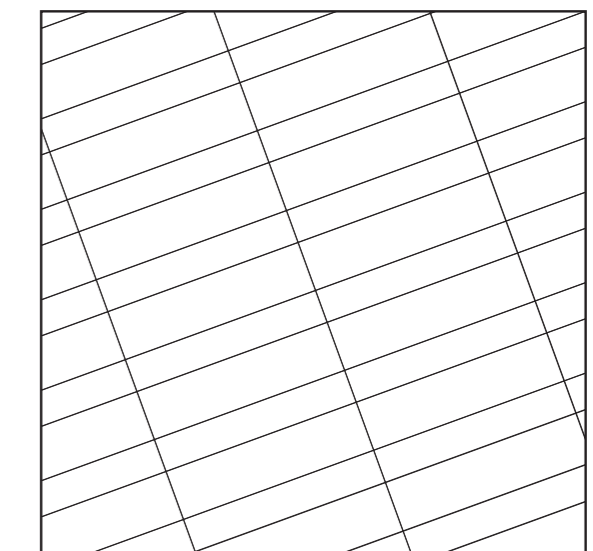

22,5x90 cm / 9"x36" (60%)
 15x90 cm / 6"x36" (40%)

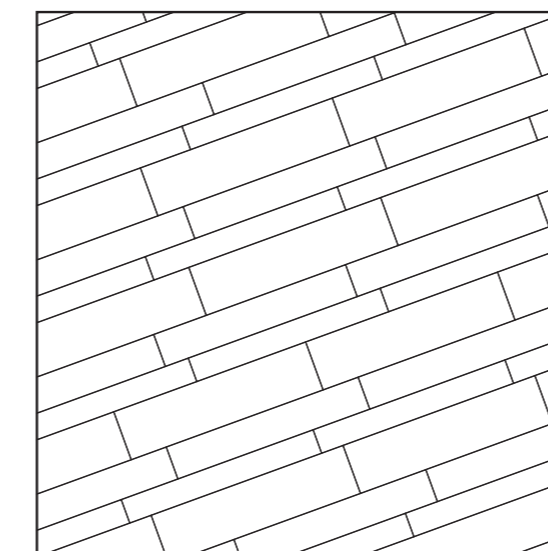

22,5x90 cm / 9"x36" (46,4%)
 15x90 cm / 6"x36" (30,9%)
 11x90 cm / 4.4"x36" (22,7%)

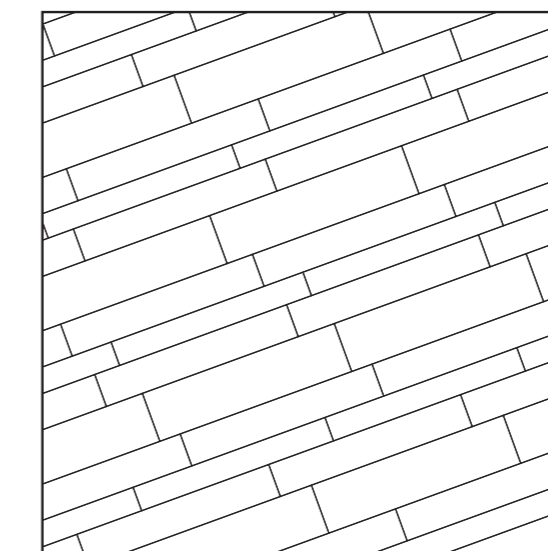

22,5x90 cm / 9"x36" (35,4%)
 15x90 cm / 6"x36" (47,2%)
 11x90 cm / 4.4"x36" (17,3%)

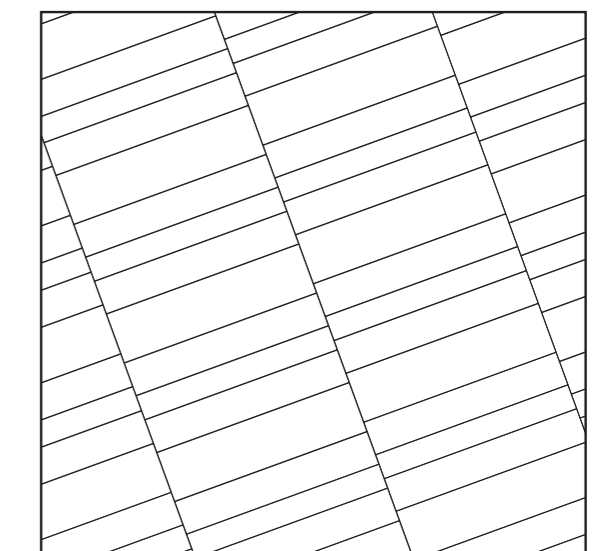

22,5x90 cm / 9"x36" (35,4%)
 15x90 cm / 6"x36" (47,2%)
 11x90 cm / 4.4"x36" (17,3%)

Formato - Size:	Spessore - Thickness:	GRES PORCELLANATO COLORATO IN MASSA	RETTIFICATO MONOCALIBRO
22,5x90 - 9" x 36"	10 mm	COLOURED IN BODY PORCELAIN STONWARE	RECTIFIED MONOCALIBER
15x90 - 6" x 36"	10 mm	GRÈS CÉRAME COLORÉ DANS LA MASSE	RECTIFIÉ MONO-CALIBRE
11x90 - 4,4" x 36"	10 mm	DURCHGEFÄRBTES FEINSTEINZEUG	GESCHLIFFEN EINKALIBRIG
		GRES PORCELÁNICO COLOREADO EN MASA	RECTIFICADO MONOCALIBRE
		КЕРАМИЧЕСКИЙ ГРАНИТ ОКРАШЕННЫЙ В МАССЕ	РЕТИФИЦИРОВАННЫЙ В ОДНОМ КАЛИБРЕ



Caratteristiche tecniche - conforme alla norma EN 14411 (ISO 13006) Appendice G gruppo Bla

Technical features - compliant with standards EN 14411 (ISO 13006) annex G group Bla

Caractéristiques techniques - Norme retenue: EN 14411 (ISO 13006) Annexe G groupe Bla

Technische Daten - Bezugsnorm: EN 14411 (ISO 13006) Anlage G Gruppe Bla

Características técnicas - en conformidad con la norma EN 14411 (ISO 13006) Anexo G grupo Bla

Технические характеристики – в соответствии со стандартом EN 14411 (ISO 13006), Приложение G группа Bla

		Caratteristica tecnica Technical features Caractéristiques techniques Technische Eigenschaften	Norma Norms Norme Norm	Valore richiesto dalle norme Required standards Valeur prescrite par les normes Normvorgabe		ETIC	
				22,5x90 / 9" x 36" 15x90 / 6" x 36" 11x90 / 4,4" x 36"	STRUTTURATO / TEXTURED 22,5x90 / 9" x 36"		
Caratteristiche di regolarità Regularity characteristics		Lunghezza e larghezza - Length and width Longuer et largeur - Länge und breite	ISO 10545-2	± 0,6%* ± 0,5%**	± 0,1% ± 0,1%	± 0,1% ± 0,1%	
		Spessore - Thickness Epaisseur - Stärke		± 5,0%	Conforme Suitable for	Conforme Suitable for	
		Rettilinearità spigoli - Straightness of sides Rectitude des arêtes - Kantengeradheit		± 0,5%	± 0,1%	± 0,1%	
	Ortogonalità - Rectangularity Orthogonalité - Rechtwinkligkeit	± 0,6%		± 0,1%	± 0,1%		
		Planarità - Surface flatness Planimetrie - Ebenflächigkeit		c.c. ± 0,5% e.c. ± 0,5% w ± 0,5%	Non applicabile a strutture forti Not applicable to "strong" structures	± 0,3% ± 0,3% ± 0,3%	Non applicabile a strutture forti Not applicable to "strong" structures
Caratteristiche strutturali Structural characteristics		Massa d'acqua assorbita - Masse d'eau absorbée Aufgenommene Wassermasse - Water absorption	ISO 10545-3	≤ 0,5%	≤ 0,1%	≤ 0,1%	
Caratteristiche meccaniche massive Bulk mechanical characteristics		Sforzo di rottura - Force de rupture Breaking strength - Bruchlast	ISO 10545-4	S ≥ 1300 N	S ≥ 2000 N	S ≥ 2000 N	
		Resistenza alla flessione - Modulus of rupture Résistance à la flexion - Biegefestigkeit		R ≥ 35 N/mm ²	R ≥ 45 N/mm ²	R ≥ 45 N/mm ²	
Caratteristiche meccaniche superficiali Surface mechanical characteristics		Durezza mohs - Mohs hardness Dureté mohs - Ritzhärte nach mohs	EN 101	≥ 6	7	8	
		Resistenza all'abrasione profonda - Resistance to deep abrasion Resistance à l'abrasion profonde Widerstand gegen tiefenverschleib	ISO 10545-6	≤ 175 mm ³	≤ 150 mm ³	≤ 150 mm ³	
Caratteristiche termo-igrometriche Thermal and hygrometric characteristics		Coefficiente di dilatazione termica lineare Coefficient of thermal linear expansion Coefficient de dilatation thermique lineaire Wärmeausdehnungskoeffizient	ISO 10545-8	Metodo di prova disponibile Test method available	≤ 7 MK ¹	≤ 7 MK ¹	
		Resistenza agli sbalzi termici - Thermal shock resistance Resistance aux variations thermiques Temperaturwechselbeständigkeit	ISO 10545-9	Metodo di prova disponibile Test method available	RESISTE RESISTANT	RESISTE RESISTANT	
		Resistenza al gelo - Resistance to frost Resistance au gel - Frostbeständigkeit	ISO 10545-12	Richiesta Required	RESISTE RESISTANT	RESISTE RESISTANT	
Caratteristiche di sicurezza Safety characteristics		Coefficiente di attrito dinamico Coefficient de frottement dynamique Dynamischer Reibungskoeffizient - Dynamic friction coefficient	METODO B.C.R.A.	D.M.I. Giugno 1989 n. 236 (μ > 0,40)	> 0,40	> 0,40	
		Coefficiente di attrito statico - Static coefficient of friction Coefficient de frottement statique Statischer reibungskoeffizient	ASTM C 1028 (S.C.O.F.)	Slip Resistant (≥ 0,60)	> 0,60 DRY > 0,60 WET	≥ 0,60 DRY ≥ 0,60 WET	
		Classificazione antidirruccio - Non-slip classification Classification antiderapant - Bewertungsgruppe trittsicherheit	DIN 51130	In funzione dell'ambiente o della zona di lavoro Basing on the environment or on the working area	R9	R11	
		Classificazione antidirruccio - Non-slip classification Classification antiderapant - Bewertungsgruppe trittsicherheit	DIN 51097	In funzione delle zone bagnate soggette a calpestio a piedi scalzi Basing on the Wet-loaded barefoot areas	A	A+B+C	
Caratteristiche chimiche Chemical characteristics		Resistenza ai prodotti chimici di uso domestico ed agli additivi per piscina Resistance to household chemicals and swimming pool salts Résistance aux produits chimiques à usage domestique et aux adjuvants pour piscines Beständigkeit gegen Haushaltschemikalien und Badewasserzusätze	ISO 10545-13	Classe UB min. Class UB min.	UA	UA	
		Resistenza a basse concentrazioni di acidi e alcali Resistance to low concentrations of acids and alkalis Résistance aux acides et aux alcalis à basse concentration Beständigkeit gegen niedrigkonzentrierte Säuren und Laugen		Secondo la classificazione indicata dal fabbricante Manufacturer to state classification	ULA	ULA	
		Resistenza ad alte concentrazioni di acidi e alcali Resistance to high concentrations of acids and alkalis Résistance aux acides et aux alcalis à haute concentration Beständigkeit gegen hochkonzentrierte Säuren und Laugen		Metodo di prova disponibile Test method available	UHA	UHA	
	Resistenza alle macchie - Resistance to staining Resistance aux taches - Widerstand gegen fleckenbildung	ISO 10545-14		Metodo di prova disponibile Test method available	5	5	

* Deviazione ammissibile, in per cento, della dimensione media di ogni piastrella (2 o 4 lati) della dimensione di fabbricazione. - The deviation, in percent, of the average size for each tile (2 or 4 sides) from the work size.

** Deviazione ammissibile, in per cento, della dimensione media di ogni piastrella (2 o 4 lati) della dimensione media dei 10 campioni (20 o 40 lati). - The deviation, in percent, of the average size for each tile (2 or 4 sides) from the average size of the 10 test specimens (20 or 40 sides).

c.c. Curvatura del centro in rapporto alla diagonale calcolata secondo le dimensioni di fabbricazione. - Centre curvature, related to diagonal calculated from the work sizes.

e.c. Curvatura dello spigolo in rapporto alle dimensioni di fabbricazione corrispondenti. - Edge curvature, related to the corresponding work sizes.

w Svergolamento in rapporto alla diagonale calcolata secondo le dimensioni di fabbricazione. - Warpage, related to diagonal calculated from the work sizes.

Il marchio Made in Italy di Atlas Concorde è sinonimo di stile, qualità ed etica. Avendo aderito con convinzione al Codice Etico di Confindustria Ceramica, Atlas Concorde appone il marchio Made in Italy su tutti i prodotti studiati, progettati e realizzati in Italia, nella fattispecie tutte le piastrelle di ceramica, le decorazioni e la maggioranza dei pezzi speciali. Solo un ristretto numero di questi ultimi è fabbricato in Spagna. I prodotti Atlas Concorde sono inoltre realizzati con tecnologie rispettose dell'ambiente, utilizzando materie prime eccellenti e sicure, garantendo le migliori condizioni di lavoro. Per queste ragioni il Made in Italy di Atlas Concorde è espressione di valori forti quali stile, design, qualità del prodotto, attenzione all'ambiente e alle persone.

Le label Made in Italy d'Atlas Concorde est synonyme de style, de qualité et d'éthique. Atlas Concorde a adhéré au Code Éthique de Confindustria Céramique avec conviction et appose le label Made in Italy sur tous les produits étudiés, projetés et fabriqués en Italie : dans ce cas, sur tous les carreaux en céramique, les décorations et la plupart des pièces spéciales. Seul un nombre restreint de ces dernières est fabriqué en Espagne. Les produits Atlas Concorde sont en outre fabriqués avec des technologies qui respectent l'environnement et utilisent des matières premières excellentes et sûres, dans la garantie des meilleurs conditions de travail. Pour ces raisons, le Made in Italy d'Atlas Concorde exprime des valeurs fortes telles que le style, le design, la qualité du produit et le respect de l'environnement et des personnes.

La marca Made in Italy de Atlas Concorde es sinónimo de estilo, calidad y ética. Adheriendo con convicción el Código Ético de Confindustria Cerámica, Atlas Concorde señala con la marca Made in Italy todos los productos estudiados, diseñados y realizados en Italia, en este caso todas las baldosas de cerámica, las decoraciones y la mayoría de piezas especiales. Sólo un restringido número de estas últimas se fabrica en España. Los productos Atlas Concorde se realizan además con tecnologías que respetan el medio ambiente, usando materias primas excelentes y seguras, garantizando las mejores condiciones de trabajo. Por dichas razones el Made in Italy de Atlas Concorde es la manifestación de valores sólidos como estilo, diseño, calidad del producto, cuidado del medio ambiente y las personas.

The Made in Italy logo of Atlas Concorde stands for style, quality and ethics. Having firmly adhered to the Ethical Code promoted by Confindustria Ceramica, Atlas Concorde places the Made in Italy logo on all the products designed and produced in Italy, that is to say ceramic tiles, decorations and the majority of special trim tiles. Only a small amount of the latter is manufactured in Spain. Atlas Concorde products are produced using eco-friendly technologies, top quality and safe raw materials with the best working conditions guaranteed for our personnel. For these reasons, Atlas Concorde's Made in Italy is the expression of strong values such as style, design, product quality, and respect for the environment and the people who live in it.

Die Marke Made in Italy von Atlas Concorde ist ein Synonym für Stil, Qualität und Ethik. Aus Überzeugung haben wir uns dem Ethischen Kodex der Confindustria Ceramica (Dachverband der ital. Unternehmen und Unternehmensverbände der Keramikbranche) angeschlossen. Atlas Concorde bringt die Marke Made in Italy auf allen seinen Produkten an die in Italien geplant, entwickelt und realisiert werden, d.h. alle Keramikfliesen, Dekore, Bordüren und der Hauptteil der Spezialteile. Nur eine geringe Anzahl der letzteren werden in Spanien gefertigt. Die Produkte von Atlas Concorde werden darüberhinaus unter Verwendung ausgezeichneter und sicherer Rohstoffe mittels umweltschützender Technologien unter besten Arbeitsbedingungen hergestellt. Aus diesen Gründen ist Made in Italy von Atlas Concorde ein Ausdruck starker Werte wie Stil, Design, Produktqualität.

Маркировка Made in Italy на плитках Atlas Concorde – синоним стиля, качества и этики. С уверенностью приняв «Этический кодекс» федерации Confindustria Ceramica (ассоциация предприятий керамической отрасли), компания отмечает этим знаком все изделия, разработанные и изготовленные в Италии: керамические плитки, декоры и большинство специальных элементов. Лишь ограниченная часть последних производится в Испании. Изделия Atlas Concorde изготовлены с использованием надежного, высококачественного сырья и передовых технологий, гарантирующих экологическую совместимость производства и оптимальные рабочие условия. Для Atlas Concorde Made in Italy – это выражение важных ценностей, таких как стиль, дизайн, качество. Это уважение к человеку и природе.



Ceramics of Italy

www.confindustriaeramica.it

Il marchio Ceramics of Italy contrassegna esclusivamente i prodotti ceramici effettivamente realizzati in Italia da un'azienda associata a Confindustria Ceramica che ha sottoscritto il Codice Etico. Il Codice, redatto dalla stessa Confindustria Ceramica, impegna a comunicare con chiarezza l'origine dei prodotti.

Le label Ceramic Tiles of Italy distingue exclusivement les produits en céramique qui sont effectivement fabriqués en Italie par les sociétés associées à Confindustria Céramique ayant souscrit le Code Éthique. Ce Code, rédigé par Confindustria Céramique, engage ceux qui le souscrivent à communiquer clairement l'origine des produits.

La marca Ceramic Tiles of Italy distingue exclusivamente los productos cerámicos realizados efectivamente en Italia por una empresa afiliada a Confindustria Cerámica que ha suscrito el Código Ético. El Código, redactado por Confindustria Cerámica, compromete a quien lo ratifica a comunicar con claridad el origen de los productos.

The Ceramic Tiles of Italy logo is an exclusive identification on ceramic products which have effectively been made in Italy by companies that are a part of the Confindustria Ceramica and who adhered to its Ethical Code. This Code, promoted and created by Confindustria Ceramica, commits all companies to communicate, clearly and with transparency, the origin of their products.

Die Marke Ceramic Tiles of Italy zeichnet ausschließlich Keramikprodukte aus, die in Italien, von Unternehmen, welche dem Dachverband der ital. Unternehmen und Unternehmensverbände der Keramikbranche angehören und sich dem Ethischen Kodex verschrieben haben, hergestellt werden. Der Kodex, von diesem Dachverband ins Leben gerufen, verpflichtet sich zur klaren Angabe und Mitteilung der Herkunft der Produkte.

Знаком Ceramics of Italy маркируются только керамические изделия, которые изготовлены действительно в Италии предприятием-членом федерации Confindustria Ceramica, подписавшим "Этический кодекс". Кодекс разработан самой федерацией и обязывает ясно указывать происхождение товара.



www.eco-label.com

Il marchio comunitario di qualità ecologica certifica il rispetto di criteri ambientali stabiliti a livello europeo ed è rilasciato esclusivamente a prodotti con un ridotto impatto ambientale rispetto ai concorrenti. Ecolabel è quindi un attestato di eccellenza che segnala e promuove i prodotti più ecologici e rispettosi dell'ambiente. I criteri ambientali valutano l'impatto in tutte le fasi del ciclo di vita: estrazione delle materie prime, processi di lavorazione, distribuzione, utilizzo, smaltimento.

Le label communautaire de qualité écologique certifie le respect de critères environnementaux au niveau européen et n'est délivré qu'aux produits qui ont un impact environnemental réduit par rapport aux concurrents. L'Écolabel est donc une attestation d'excellence qui signale et promeut les produits les plus écologiques et respectueux de l'environnement. Les critères environnementaux considèrent l'impact pour chaque phase du cycle de vie : extraction des matières premières, processus de fabrication, distribution, utilisation, élimination.

La marca comunitaria de calidad ecológica certifica el respeto de los criterios ambientales establecidos a nivel europeo y es asignada exclusivamente a productos de impacto ambiental reducido respecto a la competencia. Ecolabel es entonces un atestado de excelencia que indica y promueve los productos altamente ecológicos y respetuosos con el ambiente. Los criterios ambientales evalúan el impacto en todas las fases del ciclo de vida: extracción de las materias primas, procesos de elaboración, distribución, uso y eliminación.

The European logo of environmental quality certifies compliance with the European environmental criteria and is only given to products that, compared to those of competitors, have a low environmental impact. Ecolabel is a quality award that identifies and promotes the most eco-friendly products. The environmental criteria evaluate the impact on the entire lifecycle: extraction of raw materials, manufacturing, distribution, use and final disposal.

Die Marke ökologischer Qualität der europäischen Gemeinschaft, das europäische Umweltzeichen (Ecolabel), bestätigt die Einhaltung umweltschonender Produktionskriterien, die auf europäischer Ebene vereinbart worden sind, und wird ausschließlich an Produkte, deren Auswirkungen auf die Umwelt im Vergleich zu Mitbewerbern gering sind, verliehen. Ecolabel ist ein Attest für Außergewöhnlichkeit und fördert und unterstützt ökologische und umweltverträgliche Produkte. Die umweltschonende Kriterien gelten in allen Phasen des Lebenszyklus eines Produktes: beim Abbau von Rohstoffen, bei Bearbeitungsprozessen, beim Vertrieb und bei der Entsorgung.

Знак экологического качества ЕС удостоверяет соблюдение экологических требований, установленных на европейском уровне, и присваивается товарам, оказывающим меньшее воздействие на окружающую среду, по сравнению с существующими аналогами. Следовательно, Ecolabel является свидетельством безопасности продукции и внимательного отношения производителя к вопросам охраны природы. При выдаче сертификата оценивается воздействие изделий на среду на протяжении всего их жизненного цикла: от добычи сырья и производства до сбыта, эксплуатации и утилизации.



CERAMICHE ATLAS CONCORDE S.P.A.
41042 Spezzano di Fiorano (MO) Italia - Via Canaletto, 141
Tel. +39.0536.867811 Fax +39.0536.867985 / 867980 Export / 867981 Italia - www.atlasconcorde.it

ATLAS CONCORDE USA, INC.
2830 SW 42 Street - Hollywood, FL 33312 - U.S.A. - Phone # 954-791-3066 Fax # 954-583-0146

ООО "ATLAS CONCORDE RUSSIA"
Shosse Starositnenskoye, Vladenie 32 - 142800 Stupino - Moscovskaja Oblast - Rossijskaja Federatsija
Tel. +7-495-9161747/9160281/7206602 Fax +7-495-6231086 - www.atlasconcorde.ru

Copyright 2011 by Ceramiche Atlas Concorde S.p.A. (Spezzano di Fiorano, MO - Italy)