



evolve



atlas concorde



ARCHITECTURE&MATERIAL | ATLAS CONCORDE DESIGN

evolve

the evolution of material



MADE IN ITALY

Expression of style, quality, ethics
Espressione di stile, qualità, etica
Expression de style, qualité, éthique
Der Ausdruck des Stiles, der Qualität und Ethik
Expresión de estilo, calidad, ética
Воплощение стиля, качества, этики



TECHNICAL PORCELAIN STONEWARE - GRES PORCELLANATO TECNICO

GRÈS CÉRAME TECHNIQUE - TECHNISCHES FEINSTEINZEUG
GRES PORCELÁNICO TÉCNICO - ТЕХНИЧЕСКИЙ КЕРАМИЧЕСКИЙ ГРАНИТ

Chromatic materials

Materie cromatiche

Des matières chromatiques // Bunte Materie
Materias cromáticas // Цветовая материя



Surface variety

Varietà di superfici

Des variétés de surface // Vielfalt der Oberflächen
Variedad de superficies // Богатство фактур

Evolve Concrete Honed / Lappato



Evolve Concrete Matt



Evolve Night Textured / Strutturato



R11 A+B+C

Large sizes Grandi formati

Les grands formats // Großformate
Grandes formatos // Большие форматы



Evolve Suede 75x75

Minimum thickness Minimo spessore

L'épaisseur minimum // Minimale Stärke
Mínimo espesor // Минимальная толщина



Evolve Linea Suede

Metallic effect Effetto metallizzato

L'effet métallisé // Metallic-Effekt
Efecto metalizado // Металлический эффект



Evolve Iron



Evolve Silver

Evolve design project_01

Material and project

Materia e progetto

The chromatic selection is exalted by two delicate colour hues emphasized by a metallic effect rich in seducing reflexes.

La selezione cromatica è valorizzata da due sofisticate tonalità dall'effetto metallizzato ricco di riflettenze.



Silver

Silver Textured

Iron



Evolve Iron Lappato 60x60
Evolve Silver 30x60
Evolve Silver Strutturato 30x60 R11 A+B+C

Material and project
Materia e progetto

// La matière et le concept
// Materie und Projekt
// Materia y proyecto
// Материя и дизайн

La palette des couleurs est mise en valeur par deux teintes sophistiquées, soulignées par un effet métallisé riche de reflets séduisants.

Die Farbauswahl kommt durch die beiden raffinierten Farbtonalitäten mit ihrem verführerischen, reflektierenden Metallic-Effekt bestens zur Geltung.

La selección cromática es valorizada por dos elegantes tonalidades por un efecto metalizado rico de seductores reflejos.

Цветовая палитра Evolve обогащена двумя металлическими оттенками, пленяющими своим изящным блеском.

Evolve Silver Strutturato 30x60 R11 A+B+C

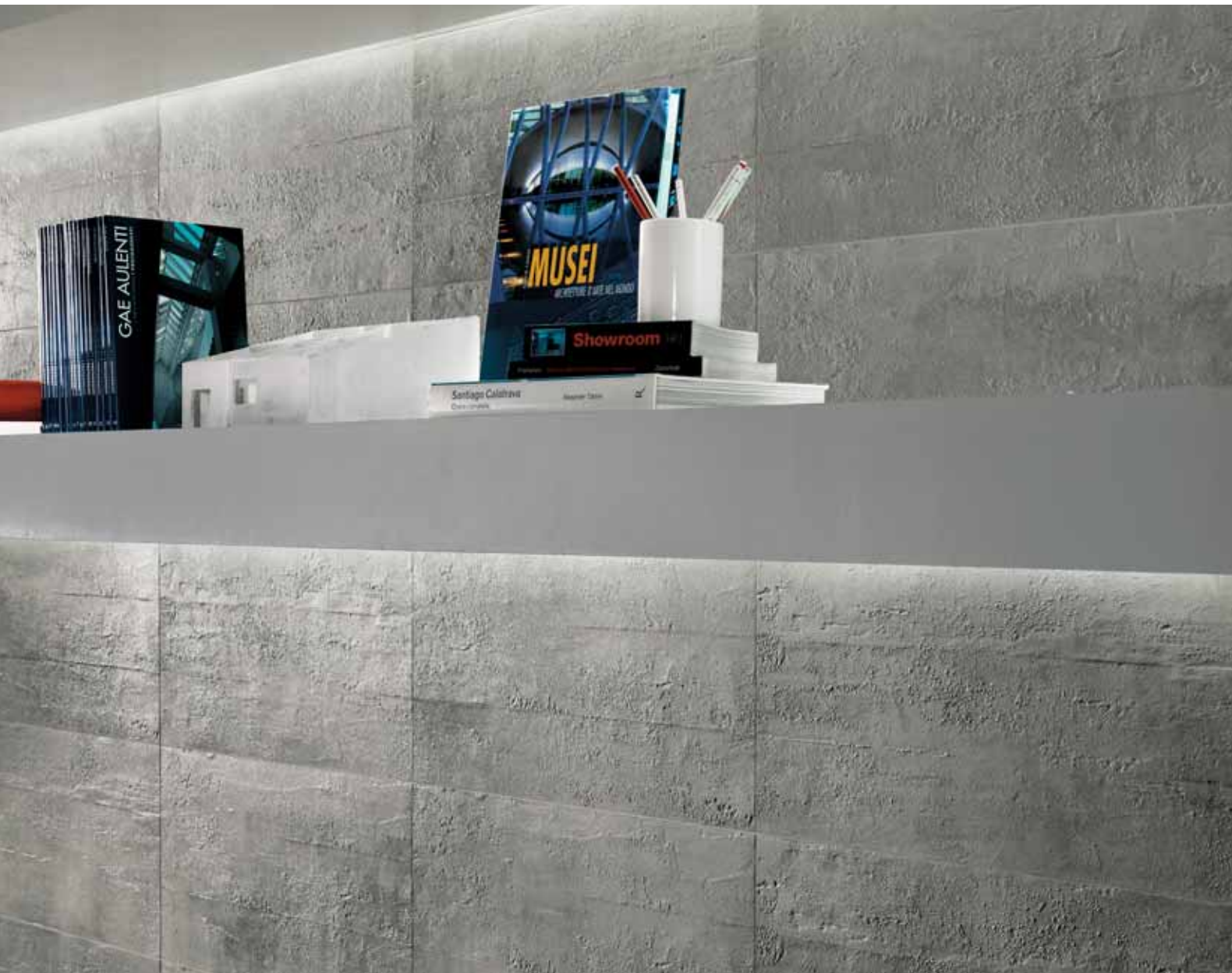

Evolve Iron Lappato 60x60
Evolve Silver Strutturato 30x60 R11 A+B+C



Evolve Iron Lappato 60x60



Evolve Silver 30x60

Material and project
Materia e progetto

- // La matière et le concept
- // Materie und Projekt
- // Materia y proyecto
- // Материя и дизайн

Evolve design project_02

Strength and appeal

Forza ed estetica

Evolve is available in the Linea version with just 4.8 mm thickness in the 30x60 size and in the decors Dogato, Broccato and Mosaico Dek.

Evolve è disponibile anche nella versione Linea di spessore 4,8 mm nel formato 30x60 e nei decori Dogato, Broccato e Mosaico Dek.



- Evolve Moka 60x60
- Evolve Suede 30x60
- Evolve Suede Brick 30x60
- Evolve Linea Suede Mosaico Dek \neq 4,8 mm
- Evolve Linea Suede 30x60 Broccato \neq 4,8 mm
- Evolve Linea Suede 30x60 Dogato \neq 4,8 mm
- Etic Ulivo 11x90



Evolve Moka 60x60
Evolve Suede Brick 30x60



Evolve Linea Suede 30x60 Dogato \neq 4,8 mm

Strength and appeal Forza ed estetica

// La force et l'aspect
// Stärke und Ästhetik
// Fuerza y estética
// Твёрдость и эстетика



Evolve Linea Suede 30x60 Broccato \neq 4,8 mm

Evolve est également disponible dans la version Linea de 4,8 mm d'épaisseur dans le format 30x60 et dans les décors Dogato, Broccato et Mosaico Dek.

Evolve ist dazu in der Version Linea, in einer Stärke von 4,8 mm, im Format 30x60 und in Dekoren Dogato, Broccato und Mosaico Dek erhältlich.

Evolve está disponible también en la versión Linea de espesor 4,8 mm en el formato 30x60 y en las decoraciones Dogato, Broccato y Mosaico Dek.

Evolve доступна также в варианте Linea толщиной 4,8 мм в формате 30x60 с декоративными элементами Dogato, Broccato и Mosaico Dek.

Evolve design project_03

Vigor and resistance

Vigore e resistenza

The textured surface guarantees safety and resistance features (R11 and A+B+C) in outdoor areas and used as a cladding, it gives an effect of vigor to the walls.

La superficie strutturata garantisce resistenza e sicurezza (R11 e A+B+C) negli spazi esterni e, usata a rivestimento, dona vigore alle pareti.

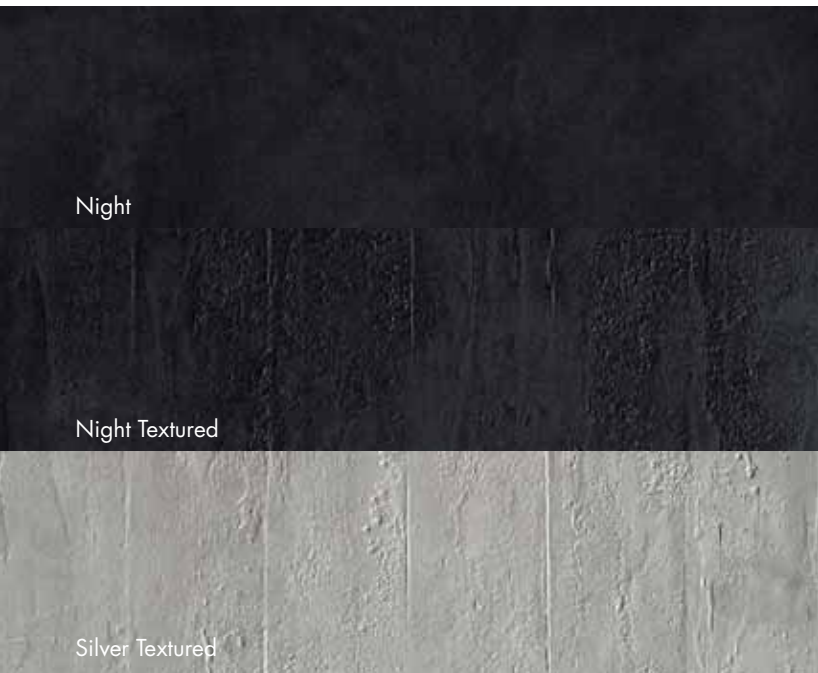

Night

Night Textured

Silver Textured

Evolve Night 60x120
Evolve Night Strutturato 60x60 R11 A+B+C
Evolve Silver Strutturato 30x60 R11 A+B+C



Vigor and resistance Vigore e resistenza

// La vigueur et la résistance
// Kraft und Strapazierfähigkeit
// Vigor y resistencia
// Сила и стойкость

Evolve Night 60x120
Evolve Night Strutturato 60x60 R11 A+B+C

La surface structurée garantit résistance et sûreté (R11 et A+B+C) à l'extérieur et, utilisée comme revêtement, elle apporte de la vigueur aux murs.

Die strukturierte Oberfläche sorgt in Außenbereichen für Strapazierfähigkeit und Sicherheit (R11 und A+B+C), als Verkleidung verwendet verleiht sie Wänden Kraft und Stärke.

La superficie estructurada garantiza resistencia y seguridad (R11 e A+B+C) en los espacios exteriores y, usada en revestimiento, brinda fuerza y vigor a las paredes.

Структурные плитки идеальны для укладки на улице, где обеспечивают стойкость и безопасность покрытий (R11 и A+B+C); стенам же они придают сильный, решительный вид.



Evolve Night 60x120

Vigor and resistance
Vigore e resistenza

// La vigueur et la résistance
// Kraft und Strapazierfähigkeit
// Vigor y resistencia
// Сила и стойкость

Evolve Night Strutturato 60x60 R11 A+B+C



Evolve Night Strutturato 60x60 R11 A+B+C

Evolve design project_04

Thoroughness and harmony

Completezza e armonia

The new 75x75 size distinguishes itself thanks to its great visual impact and originality while the trim tiles complete the project to the smallest of details.

Il nuovo formato 75x75 si distingue per impatto visivo e originalità mentre i pezzi speciali completano il progetto con massima precisione.



Evolve Suede Strutturato 30x60 R11 A+B+C
Evolve Suede Elemento L Strutturato 15x60 H4 R11 A+B+C
Evolve Suede 75x75
Evolve White Brick 30x60





Evolve Suede 75x75



Evolve Suede Strutturato 30x60 R11 A+B+C
Evolve Suede Elemento L Strutturato 15x60 H4 R11 A+B+C

Thoroughness and harmony Completezza e armonia

// La complétude et l'harmonie
// Vollständigkeit und Harmonie
// Acabado y armonía
// Полнота и гармония

Le nouveau format 75x75 se distingue par son impact visuel et son originalité et les pièces spéciales complètent le projet avec extrême précision.

Das neue Format 75x75 zeichnet sich durch seine Optik und seine Originalität aus und die Formteile vervollständigen das Projekt mit höchster Präzision.

El nuevo formato 75x75 se distingue por el impacto visual y por la originalidad a la vez que las piezas especiales completan el proyecto con la máxima precisión.

Новый формат 75x75 придаёт домашним пространствам выразительность и оригинальность, а специальные элементы эффектно дополняют проекты.

Thoroughness and harmony
Completeness and harmony

// La complétude et l'harmonie
// Vollständigkeit und Harmonie
// Acabado y armonía
// Полнота и гармония

Evolve White Brick 30x60



Evolve Suede 75x75
Evolve White 75x75
Evolve Linea White Mosaico Dek 30x30 \neq 4,8 mm
Evolve Linea Suede Mosaico Dek 30x30 \neq 4,8 mm



Evolve design project_05

Potential and versatility

Potenzialità e versatilità

Three surface finishes: matt, with sought-after surface graphics, honed, with a soft-touch and a "resin-like effect" and textured, that recalls the effect of cement gauge box.

Tre finiture: matt, dalla grafica materica, lappata, con mano morbida e "effetto resina", strutturata, con effetto di impressione della cassaforma sul cemento.

Ice

Concrete

Moka Textured

Evolve Concrete Lappato 60x60
 Evolve Concrete 60x60
 Evolve Ice 60x60
 Evolve Ice Scalino 33x60
 Evolve Moka Strutturato 60x60 R11 A+B+C



Potential and versatility
Potenzialità e versatilità

- // Le potentiel et la versatilité
- // Potential und Vielseitigkeit
- // Potencialidad y versatilidad
- // Богатый потенциал и многогранность

Evolve Concrete 60x60
Evolve Ice 60x60



Trois finitions de surface : matt, avec un graphisme élaboré de matière ; adoucie, douce au toucher avec un effet résine, et structurée qui reproduit l'empreinte du coffrage sur le ciment.

Drei Oberflächenfinishes: matt, mit raffinierter Grafik, geläpft, mit weichem Griff und "Harzeffekt", strukturiert, welches den Effekt von Betonschalungen aufnimmt.

Evolve Moka Strutturato 60x60 R11 A+B+C



Tres acabados: mate, de sofisticado diseño material, pulido, con mano suave y "efecto resina", estructurado, con efecto del encofrado estampado en el cemento.

Доступны три варианта отделки поверхности: матовый, сохраняющий естественный вид материала, шлифованный, напоминающий мягкость натуральных смол, и структурный, будто воспроизводящий отпечаток опалубки на цементе.



Evolve Ice 60x60
Evolve Ice Scalino 33x60

Evolve design project_06

Reliability and safety

Affidabilità e sicurezza

Evolve allows a safe use even in public areas and venues where the elegant 60x120 slab exalts the aesthetics of the surface.

Evolve consente un utilizzo sicuro anche in spazi adibiti ad uso pubblico dove l'elegante lastra 60x120 esalta l'estetica materica della superficie.



White



Evolve White 60x120



Evolve White 60x120
Evolve Linea White 30x60 Dogato \neq 4,8 mm



Evolve Linea White 30x60 Dogato \neq 4,8 mm

Reliability and safety **Affidabilità e sicurezza**

- // Fiabilité et sécurité
- // Zuverlässigkeit und Sicherheit
- // Fiabilidad y seguridad
- // Надёжность и безопасность

Evolve permet une utilisation sûre même dans les espaces destinés au public et l'élégance de la dalle 60x120 souligne la beauté de la matière des surfaces.

Evolve ermöglicht eine sichere Verwendung auch in öffentlichen Bereichen, wo die elegante Platte 60x120 betont die Materialästhetik der Oberfläche.

Evolve permite una utilización segura incluso en espacios destinados a un uso público en donde la elegante losa de 60x120 exalta la estética material de la superficie.

Коллекция Evolve может быть уложена и в общественных интерьерах, где элегантный формат 60x120 эффектно подчеркнёт незаурядную эстетику её поверхности.

TECHNICAL PORCELAIN STONEWARE - RECTIFIED MONOCALIBER / GRES PORCELLANATO TECNICO - RETTIFICATO MONOCALIBRO
 GRÉS CÉRAMÉ TECHNIQUE - RECTIFIÉ MONO-CALIBRE / TECHNISCHES FEINSTEINZEUG - GESCHLIFFEN EINKALIBRIG / GRES PORCELÁNICO TÉCNICO - RECTIFICADO MONOCALIBRE / ТЕХНИЧЕСКИЙ КЕРАМИЧЕСКИЙ ГРАНИТ - РЕТИФИЦИРОВАННЫЙ В ОДНОМ КАЛИБРЕ

60x120 cm
23⁵/₈"x47¹/₄"

Colours / Colori

- White
- Suede
- Concrete
- Night
- Silver

Thickness / Spessore
10 mm

75x75 cm
29¹/₂"x29¹/₂"

Colours / Colori

- White
- Suede
- Concrete
- Night
- Silver

Thickness / Spessore
10 mm

60x60 cm
23⁵/₈"x23⁵/₈" *

Thickness / Spessore
10 mm

30x60 cm
11³/₄"x23⁵/₈" *

Thickness / Spessore
10 mm

LINEA 4,8 mm

30x60 cm
11³/₄"x23⁵/₈" *

Thickness / Spessore
4,8 mm

* Available in all colours
 Disponibile in tutti i colori
 Disponible dans toutes les couleurs
 In allen Farben Verfügbar
 Disponibles en todos los colores
 Имеются все цвета

Colours



Evolve White V2



Evolve Ice V2



Evolve Suede V2



Evolve Concrete V2



Evolve Moka V2



Evolve Night V2

Metallic Colours



Evolve Silver V2



Evolve Iron V2

Evolve White

Evolve Suede

Evolve Moka

Evolve Night

Evolve Concrete

Evolve Ice

Evolve Silver

Evolve Iron

Matt
Matt
Mat
Matt
Mate
Матовая



Honed
Lappato
Adouci
Geläpft
Вру́идо
Полуполированный



Textured
Strutturato
Structuré
Strukturiert
Estructurado
Структурная

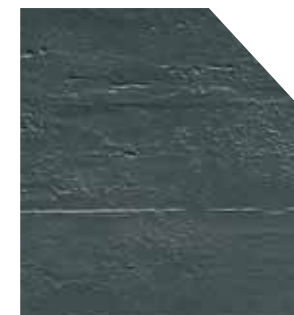

	White	Suede	Moka	Night	Concrete	Ice	Silver	Iron
Matt / Matt								
60x120 cm / 23 ⁵ / ₈ "x47 ¹ / ₄ "	●	●		●	●		●	
75x75 cm / 29 ¹ / ₂ "x29 ¹ / ₂ "	●	●		●	●		●	
60x60 cm / 23 ⁵ / ₈ "x23 ⁵ / ₈ "	●	●	●	●	●	●	●	●
30x60 cm / 11 ³ / ₄ "x23 ⁵ / ₈ "	●	●	●	●	●	●	●	●
Honed / Lappato								
60x60 cm / 23 ⁵ / ₈ "x23 ⁵ / ₈ "	●	●	●	●	●	●	●	●
Textured / Strutturato								
60x60 cm / 23 ⁵ / ₈ "x23 ⁵ / ₈ "	●	●	●	●	●	●	●	●
30x60 cm / 11 ³ / ₄ "x23 ⁵ / ₈ "	●	●	●	●	●	●	●	●

LINEA 4,8 mm

30x60 cm / 11 ³ / ₄ "x23 ⁵ / ₈ "	●	●	●	●	●	●	●	●

GREEN PROJECT - LEED



Manufactured with minimum 20% of pre-consumer recycled materials, it can contribute to the awarding of 1 LEED credit. / Contiene oltre il 20% di materiale riciclato pre-consumer e può contribuire al raggiungimento di 1 credito LEED. / Contient plus de 20% de matière recyclée pré-consumer et il peut contribuer à obtenir 1 crédit LEED. / Enthält 20% pre-consumer Recyclingmaterial welches zur Erreichung von 1 LEED Punkten beitragen kann. / Contiene más de un 20% de materiales reciclados pre-consumer y puede contribuir al conseguimento de 1 punto LEED. / Содержит не менее 20% рециклированного до потребления материала что может способствовать накоплению 1 балла по стандарту LEED.



Manufactured with minimum 40% of pre-consumer recycled materials, it can contribute to the awarding of 2 LEED credits. / Contiene oltre il 40% di materiale riciclato pre-consumer e può contribuire al raggiungimento di 2 crediti LEED. / Contient plus de 40% de matière recyclée pré-consumer et il peut contribuer à obtenir 2 crédits LEED. / Enthält 40% pre-consumer Recyclingmaterial welches zur Erreichung von 2 LEED Punkten beitragen kann. / Contiene más de un 40% de materiales reciclados pre-consumer y puede contribuir al conseguimento de 2 puntos LEED. / Содержит не менее 40% рециклированного до потребления материала, что может способствовать получению 2 баллов по стандарту LEED.

Trim tiles. Pezzi speciali.

INDOOR TRIM TILES

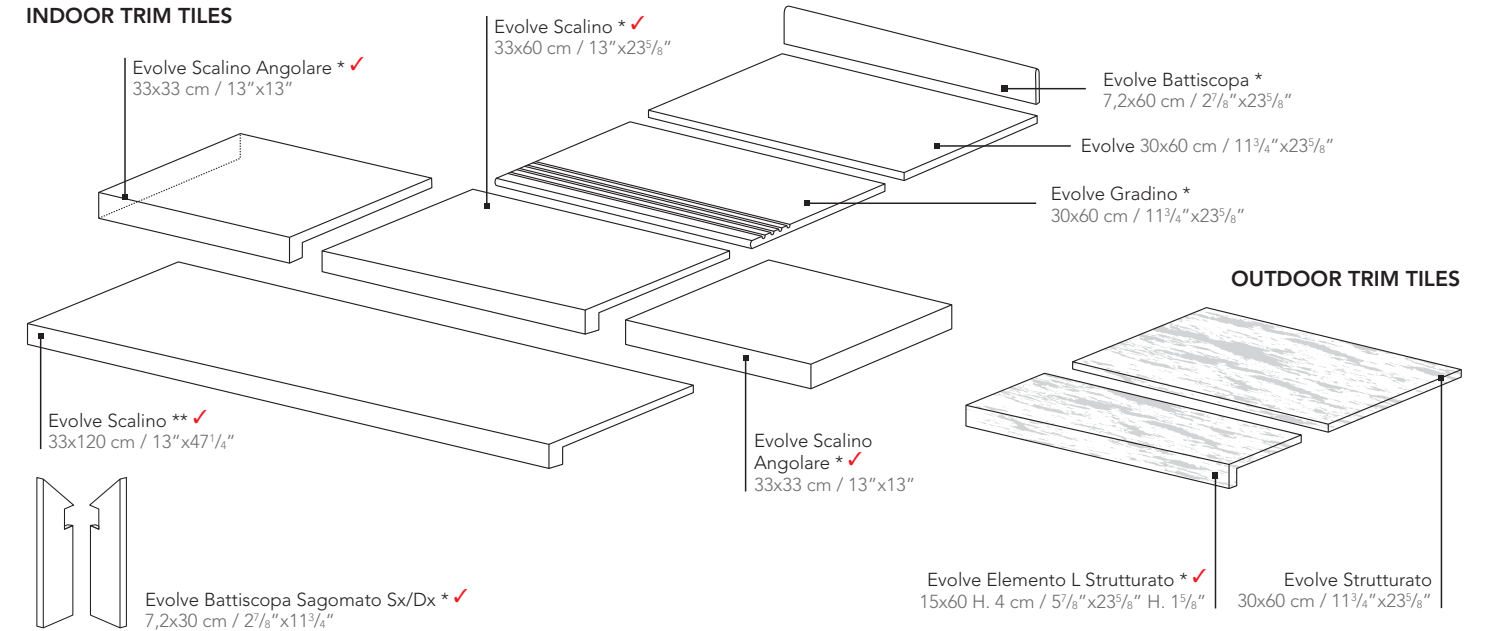

* Available in all colours / Disponibile in tutti i colori
 Disponible dans toutes les couleurs / In allen Farben Verfügbar
 Disponible en los colores / Имеющиеся цвета

** Available in the following colours / Disponibile nei seguenti colori
 Disponible dans les couleurs suivantes / In folgenden Farben Verfügbar
 Disponible en los colores / Имеющиеся цвета:
White, Suede, Concrete, Night, Silver

✓ These parts are supplied to order / I pezzi sono disponibili su ordinazione
 Les pièces sont disponibles sur commande / Die Teile sind auf Bestellung lieferbar
 Las piezas se hacen por encargo / Изготавливаются на заказ

Stonizzazione. Colour-shading.



V2

Tutti i prodotti della collezione Evolve si caratterizzano per una variazione cromatica e superficiale da lieve a moderata. The products of the Evolve collection are characterized by a light or moderate chromatic shading on their surface.

Tous les produits de la collection Evolve sont caractérisés par des variations de couleur et de surface allant de légères à modérées. / Alle Produkte der Kollektion Evolve zeichnen sich durch eine Veränderung der Farbe und der Oberfläche von leicht bis mittel aus. / Todos los productos de la colección se caracterizan por una variación cromática y de superficie leve o moderada. / Все изделия коллекции Evolve отличаются поверхностной цветовой неоднородностью: от легкой до умеренной.

V1

Leggera
Light
Léger
Leichte
Ligera
Легкое

V2

Moderata
Moderate
Moyen
Mittlere
Moderada
Умеренное

V3

Alta
High
Haut
Kräftigere
Alta
Высокое

V4

Random
Random
Casual
Zufällige
Random
Произвольное

Classificazione UPEC - in via di certificazione. Classification UPEC - en cours de certification.

Colore / Colour / Couleur Farbe / Color / Цвет	Formato / Size / Format Format / Formato / Размер	Superficie / Surface / Surface Oberfläche / Superficie / Поверхность	
White, Suede, Concrete, Night, Silver	60x120 - 75x75	Matt / Mat	U4 P3 E3 C2
White, Ice, Suede, Concrete, Moka, Night, Silver, Iron	60x60	Matt / Mat	U4 P4 E3 C2
	30x60	Strutturato / Structuré	U4 P3 E3 C2
White, Ice, Suede, Concrete, Moka, Night, Silver, Iron	60x60	Lappato / Adouci	U4 P4 E3 C2

Thickness / Spessore: 4,8 mm



Evolve Linea White 30x60 Dogato
30x60 cm / 11³/₄"x23⁵/₈"



Evolve Linea Suede 30x60 Dogato
30x60 cm / 11³/₄"x23⁵/₈"



Evolve Linea Silver 30x60 Dogato
30x60 cm / 11³/₄"x23⁵/₈"



Evolve Linea Night 30x60 Dogato
30x60 cm / 11³/₄"x23⁵/₈"



Evolve Linea Concrete 30x60 Dogato
30x60 cm / 11³/₄"x23⁵/₈"



Evolve Linea White 30x60 Broccato
30x60 cm / 11³/₄"x23⁵/₈"



Evolve Linea Suede 30x60 Broccato
30x60 cm / 11³/₄"x23⁵/₈"



Evolve Linea Silver 30x60 Broccato
30x60 cm / 11³/₄"x23⁵/₈"



Evolve Linea Night 30x60 Broccato
30x60 cm / 11³/₄"x23⁵/₈"



Evolve Linea Concrete 30x60 Broccato
30x60 cm / 11³/₄"x23⁵/₈"

Thickness / Spessore: 4,8 mm

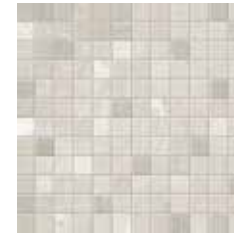

Evolve Linea White Mosaico Dek
30x30 cm / 11³/₄"x11³/₄"

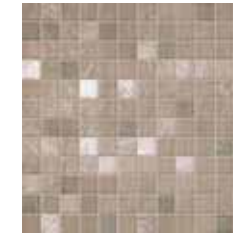

Evolve Linea Suede Mosaico Dek
30x30 cm / 11³/₄"x11³/₄"

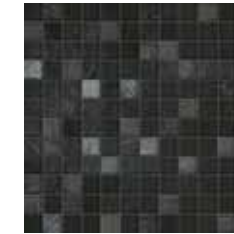

Evolve Linea Moka Mosaico Dek
30x30 cm / 11³/₄"x11³/₄"

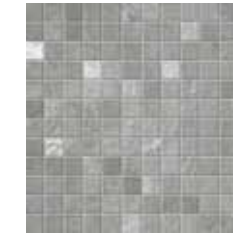

Evolve Linea Silver Mosaico Dek
30x30 cm / 11³/₄"x11³/₄"

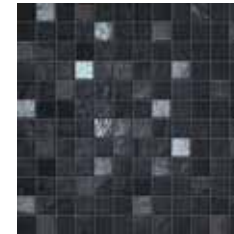

Evolve Linea Night Mosaico Dek
30x30 cm / 11³/₄"x11³/₄"

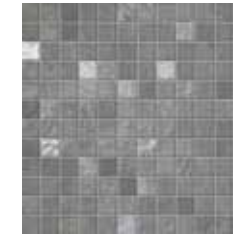

Evolve Linea Concrete Mosaico Dek
30x30 cm / 11³/₄"x11³/₄"

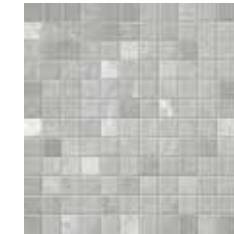

Evolve Linea Ice Mosaico Dek
30x30 cm / 11³/₄"x11³/₄"

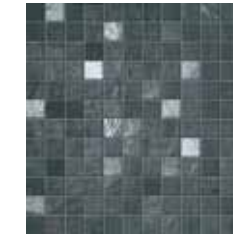

Evolve Linea Iron Mosaico Dek
30x30 cm / 11³/₄"x11³/₄"

Linea Metal Satin Listello 60 ♦
0,5x60 cm / 1/4"x23⁵/₈"

♦ Metal insert / Insetto in metallo
Pièce spéciale en métal / Metall-Einleger
Aplicación en metal / Вставка из металла

Thickness / Spessore: 10 mm

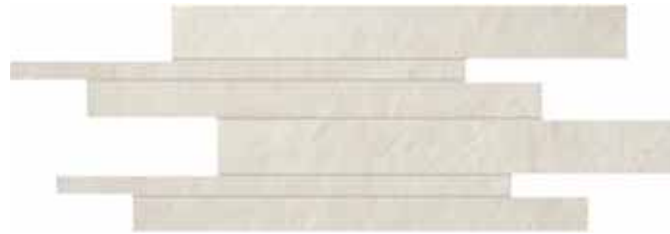

Evolve White Brick
30x60 cm / 11³/₄"x23⁵/₈"



Evolve Suede Brick
30x60 cm / 11³/₄"x23⁵/₈"



Evolve Moka Brick
30x60 cm / 11³/₄"x23⁵/₈"

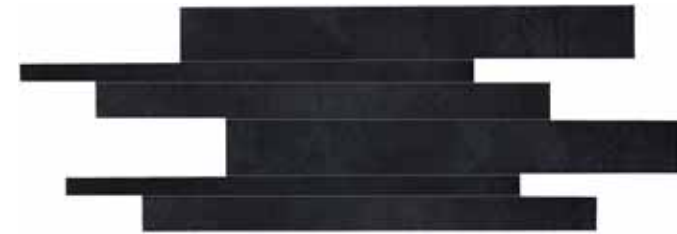

Evolve Night Brick
30x60 cm / 11³/₄"x23⁵/₈"



Evolve Ice Brick
30x60 cm / 11³/₄"x23⁵/₈"

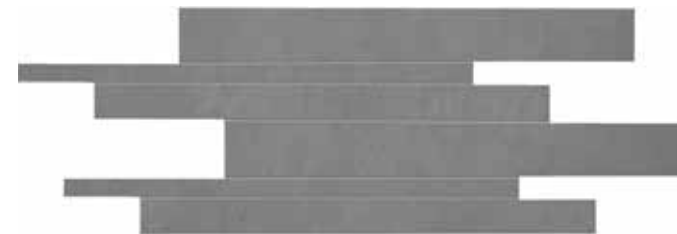

Evolve Concrete Brick
30x60 cm / 11³/₄"x23⁵/₈"



Evolve Silver Brick
30x60 cm / 11³/₄"x23⁵/₈"



Evolve Iron Brick
30x60 cm / 11³/₄"x23⁵/₈"

Thickness / Spessore: 10 mm



Evolve White Mosaico
30x30 cm / 11³/₄"x11³/₄"



Evolve Suede Mosaico
30x30 cm / 11³/₄"x11³/₄"



Evolve Moka Mosaico
30x30 cm / 11³/₄"x11³/₄"

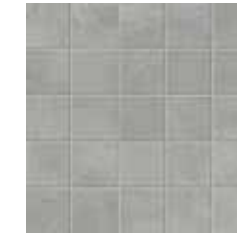

Evolve Silver Mosaico
30x30 cm / 11³/₄"x11³/₄"

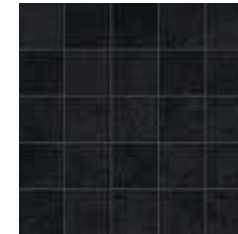

Evolve Night Mosaico
30x30 cm / 11³/₄"x11³/₄"



Evolve Concrete Mosaico
30x30 cm / 11³/₄"x11³/₄"



Evolve Ice Mosaico
30x30 cm / 11³/₄"x11³/₄"



Evolve Iron Mosaico
30x30 cm / 11³/₄"x11³/₄"



Metal Satin Listello 120 ♦
1,5x120 cm / 5/8"x47 1/4"



Metal Satin Listello 75 ♦
1x75 cm / 3/8"x29 1/2"



Metal Satin Angolo 1 ♦
1x1 cm / 3/8"x3/8"



Metal Satin Listello 60 ♦
1,5x60 cm / 0.6"x23 5/8"



Metal Satin Angolo 1,5 ♦
1,5x1,5 cm / 5/8"x5/8"



Metal Lev. Listello 60 ♦
0,6x60 cm / 1/4"x23 5/8"



Metal Lev. Angolo 0,6 ♦
0,6x0,6 cm / 1/4"x1/4"



Metal Glossy Listello 60 ♦
0,3x60 cm / 1/8"x23 5/8"

♦ Metal insert / Insetto in metallo
Pièce spéciale en métal / Metall-Einleger
Aplicación en metal / Вставка из металла

Size - Formato:	Thickness - Spessore:	TECHNICAL PORCELAIN STONEWARE	RECTIFIED MONOCALIBER
60x120 cm / 23 ⁵ / ₈ "x47 ¹ / ₄ "	10 mm	GRES PORCELLANATO TECNICO	RETTIFICATO MONOCALIBRO
75x75 cm / 29 ¹ / ₂ "x29 ¹ / ₂ "	10 mm	GRÉS CÉRAMÉ TECHNIQUE	RECTIFIÉ MONO-CALIBRE
60x60 cm / 23 ⁵ / ₈ "x23 ⁵ / ₈ "	10 mm	TECHNISCHES FEINSTEINZEUG	GESCHLIFFEN EINKALIBRIG
30x60 cm / 11 ³ / ₄ "x23 ⁵ / ₈ "	10 mm	GRES PORCELÁNICO TÉCNICO	RECTIFICADO MONOCALIBRE
30x60 cm / 11 ³ / ₄ "x23 ⁵ / ₈ "	4,8 mm - Linea 4,8mm	ТЕХНИЧЕСКИЙ КЕРАМИЧЕСКИЙ ГРАНИТ	РЕТИФИЦИРОВАННЫЙ В ОДНОМ КАЛИБРЕ



Technical features - compliant with standards EN 14411 (ISO 13006) annex G group B1a
 Caratteristiche tecniche - conforme alla norma EN 14411 (ISO 13006) Appendice G gruppo B1a

Caractéristiques techniques - Norme retenue: EN 14411 (ISO 13006) Annexe G groupe B1a

Technische Daten - Bezugsnorm: EN 14411 (ISO 13006) Anlage G Gruppe B1a

Características técnicas - en conformidad con la norma EN 14411 (ISO 13006) Anexo G grupo B1a

Технические характеристики - в соответствии со стандартом EN 14411 (ISO 13006), Приложение G группа B1a

	Caratteristica tecnica Technical features Caractéristiques techniques Technische Eigenschaften	Norma Norme Norme	Valore richiesto dalle norme Required standards Valeur prescrite par les normes Normvorgabe		evolve			LINEA 4.8 mm
			MATT	LAPP.	STR.	MATT		
Caratteristiche di regolarità Regularly characteristics	Lunghezza e larghezza - Length and width Longeur et largeur - Länge und breite	ISO 10545-2	± 0,6%*	± 0,1%	± 0,1%	± 0,1%	± 0,1%	
	Spessore - Thickness Épaisseur - Stärke		± 0,5%**	± 0,1%	± 0,1%	± 0,1%	± 0,1%	
	Rettilinearità spigoli - Straightness of sides Rectitude des arêtes - Kantengeradheit		± 5,0%	Conforme Suitable for	Conforme Suitable for	Conforme Suitable for	Conforme Suitable for	
	Ortogonalità - Rectangularity Orthogonalité - Rechtwinkligkeit		± 0,5%	± 0,1%	± 0,1%	± 0,1%	± 0,1%	
Caratteristiche strutturali Structural characteristics	Planarità - Surface flatness Planimétrie - Ebenflächigkeit	ISO 10545-3	± 0,6%	± 0,1%	± 0,1%	± 0,1%	± 0,1%	
	Massa d'acqua assorbita - Masse d'eau absorbée Aufgenommene Wassermasse - Water absorption		c.c. ± 0,5% e.c. ± 0,5% w ± 0,5%	Non applicabile a strutturati forti Not applicable to "strong" structures	± 0,3% ± 0,3% ± 0,3%	± 0,2% ± 0,2% ± 0,2%	Non applicabile a strutturati forti Not applicable to "strong" structures	± 0,3% ± 0,3% ± 0,3%
Caratteristiche Meccaniche massive Bulk mechanical characteristics	Sforzo di rottura - Force de rupture Breaking strength - Bruchlast	ISO 10545-4	S ≥ 1300 N	S ≥ 700 N Linea	S ≥ 1500 N	S ≥ 1500 N	S ≥ 1500 N	S ≥ 700 N
	Resistenza alla flessione - Modulus of rupture Résistance à la flexion - Biegefestigkeit		R ≥ 35 N/mm ²	R ≥ 40 N/mm ²	R ≥ 40 N/mm ²	R ≥ 40 N/mm ²	R ≥ 40 N/mm ²	
Caratteristiche meccaniche superficiali Surface mechanical characteristics	Durezza mohs - Mohs hardness Durete mohs - Ritzhärte nach mohs	EN 101	MATT - STR. ≥ 6	LAPP. -	Conforme Suitable for	5	8	Conforme Suitable for
	Resistenza all'abrasione profonda - Resistance to deep abrasion Résistance a l'abrasion profonde Widerstand gegen tiefenverschleib	ISO 10545-6	≤ 175 mm ³	≤ 150 mm ³	≤ 150 mm ³	Conforme Suitable for	≤ 150 mm ³	
Caratteristiche termo-igrometriche Thermal and hygrometric characteristics	Coefficiente di dilatazione termica lineare Coefficient of thermal linear expansion Coefficient de dilatation thermique lineaire Wärmeausdehnungskoeffizient	ISO 10545-8	Metodo di prova disponibile Test method available	≤ 7 MK ⁻¹	≤ 7 MK ⁻¹	≤ 7 MK ⁻¹	≤ 7 MK ⁻¹	
	Resistenza agli sbalzi termici - Thermal shock resistance Résistance aux variations thermiques Temperaturwechselbeständigkeit	ISO 10545-9	Metodo di prova disponibile Test method available	RESISTE RESISTANT	RESISTE RESISTANT	RESISTE RESISTANT	RESISTE RESISTANT	
	Resistenza al gelo - Resistance to frost Résistance au gel - Frostbeständigkeit	ISO 10545-12	Richiesta Required	RESISTE RESISTANT	RESISTE RESISTANT	RESISTE RESISTANT	RESISTE RESISTANT	
Caratteristiche di sicurezza Safety characteristics	Coefficiente di attrito dinamico Coefficient de frottement dynamique Dynamischer Reibungskoeffizient - Dynamic friction coefficient	METODO B.C.R.A.	D.M.I. Giugno 1989 n. 236 (μ > 0,40)	> 0,40	< 0,40	> 0,40	> 0,40	
	Coefficiente di attrito statico - Static coefficient of friction Coefficient de frottement statique - Statischer Reibungskoeffizient	ASTM C 1028 (S.C.O.F.)	Slip Resistant (≥ 0,60)	≥ 0,60 DRY ≥ 0,60 WET	≥ 0,60 DRY 0,50 ÷ 0,60 WET	≥ 0,60 DRY ≥ 0,60 WET	≥ 0,60 DRY ≥ 0,60 WET	
	Classificazione antiscivolo - Non-slip classification Classification antiderapant - Bewertungsgruppe Trittsicherheit	DIN 51130	In funzione dell'ambiente o della zona di lavoro - Basing on the environment or on the working area	R9	N.C.	R11	R9	
	Classificazione antiscivolo - Non-slip classification Classification antiderapant - Bewertungsgruppe Trittsicherheit	DIN 51097	In funzione delle zone bagnate soggette a calpestio a piedi scalzi Basing on the Wet-loaded barefoot areas	-	-	A+B+C	-	
Caratteristiche chimiche Chemical characteristics	Resistenza ai prodotti chimici di uso domestico ed agli additivi per piscina Resistance to household chemicals and swimming pool salts Résistance aux produits chimiques à usage domestique et aux adjuvants pour piscines Beständigkeit gegen Haushaltschemikalien und Badewasserzusätze	ISO 10545-13	Classe UB min. Class UB min.	UA	UA	UA	UA	
	Resistenza a basse concentrazioni di acidi e alcali Resistance to low concentrations of acids and alkalis Résistance aux acides et aux alcalis à basse concentration Beständigkeit gegen niedrigkonzentrierte Säuren und Laugen		Secondo la classificazione indicata dal fabbricante Manufacturer to state classification	ULA	ULA	ULA	ULA	
	Resistenza ad alte concentrazioni di acidi e alcali Resistance to high concentrations of acids and alkalis Résistance aux acides et aux alcalis à haute concentration Beständigkeit gegen hochkonzentrierte Säuren und Laugen		Metodo di prova disponibile Test method available	UHA	UHA	UHA	UHA	
	Resistenza alle macchie - Resistance to staining Résistance aux taches - Widerstand gegen fleckenbildung	ISO 10545-14	Metodo di prova disponibile Test method available	5	5	5	5	

* The deviation, in percent, of the average size for each tile (2 or 4 sides) from the work size. - Deviazione ammissibile, in per cento, della dimensione media di ogni piastrella (2 o 4 lati) della dimensione di fabbricazione.

** The deviation, in percent, of the average size for each tile (2 or 4 sides) from the average size of the 10 test specimens (20 or 40 sides).

Deviations ammissible, in per cento, della dimensione media di ogni piastrella (2 o 4 lati) della dimensione media dei 10 campioni (20 o 40 lati).

c.c. Centre curvature, related to diagonals calculated from the work sizes. - Curvatura del centro in rapporto alla diagonale calcolata secondo le dimensioni di fabbricazione.

e.c. Edge curvature, related to the corresponding work sizes. - Curvatura dello spigolo in rapporto alle dimensioni di fabbricazione corrispondenti.

w Warpage, related to diagonal calculated from the work sizes. - Sverglamento in rapporto alla diagonale calcolata secondo le dimensioni di fabbricazione.



Notes. Note.

For information and details relating to codes, packaging and weight it is recommended to refer to the latest pricelist / Per le informazioni e i dati relativi a codici, imballaggi e pesi occorre sempre consultare l'ultimo listino aggiornato e in vigore / Pour toutes informations et renseignements concernant les codes, les emballages et les poids, il y a toujours lieu de consulter le dernier tarif en vigueur et mis à jour / Für Informationen und Daten die den Code, die Verpackung und das Gewicht betreffen bitte die aktuellste Preisliste zugrunde legen / Para acceder a la información y a los datos relativos a códigos, embalajes y pesos hay que consultar siempre la última lista de precios actualizada y vigente / Для информации о кодах, упаковках и весе обращайтесь к последнему действующему прайс-листу.

Colours and optical features of the materials illustrated in this catalogue are to be regarded as mere indications / I colori e le caratteristiche estetiche dei materiali illustrati nel presente catalogo sono da ritenersi puramente indicativi / Les coloris et les caractéristiques esthétiques des références illustrées dans le catalogue sont donnés à titre purement indicatif / Die Farben und die ästhetischen Eigenschaften der in diesem Katalog abgebildeten Produkte sind als reine Richtwerte zu betrachten / Los colores y las características estéticas de los materiales ilustrados en el presente catálogo deben ser considerados como puramente indicativos / Цвета и эстетические характеристики описанных в настоящем каталоге материалов являются только ориентировочными.

Atlas Concorde reserves the right to modify any product without notice and will not be liable for any direct or indirect damage resulting from such modifications / Atlas Concorde si riserva di modificare i prodotti senza preavviso, declinando ogni responsabilità su eventuali danni diretti o indiretti derivanti da eventuali modifiche / Atlas Concorde se réserve le droit de modifier ses produits sans préavis et décline toute responsabilité concernant les éventuels dommages directs ou indirects qui pourraient dériver de ces modifications / Atlas Concorde behält sich das Recht vor jederzeit und ohne vorherige Ankündigung, die Produkte zu verändern, und lehnt jede Haftung bei direkten oder indirekten Schäden ab, die von diesen Veränderungen herrühren / Atlas Concorde se reserva el derecho de modificar los productos sin previo aviso, rechaza cualquier responsabilidad sobre eventuales daños directos o indirectos derivados de eventuales modificaciones / Atlas Concorde оставляет за собой право изменять характеристики изделий без предварительного уведомления, отклоняя при этом любую ответственность за прямые или косвенные убытки, возникшие в результате изменений.



The LEED standard (Leadership in Energy and Environmental Design) is a rating system dedicated to the development of “green” buildings. Developed by the US Green Building Council and internationally recognised, it points out the necessary requirements to build eco-compatible projects, capable of functioning in a sustainable and autonomous way from an energy point of view, as well as having a low environmental impact throughout their entire life cycle. This system is based on the allocation of credits for each single requirement: the total amount of credits defines the obtained certification level. Also ceramic tiles can contribute to the achievement of LEED points. Ceramiche Atlas Concorde is a member of the US Green Building Council as well as ordinary member of the Green Building Council Italia, the Italian promoter entity of the LEED standard.

Le standard LEED (Leadership in Energy and Environmental Design) est un système pour l'évaluation visant au développement d'édifices écologiques. Élaboré par l'US Green Building Council, il est reconnu au niveau international et précise les critères pour construire des édifices compatibles avec l'environnement, capables de fonctionner de manière durable et autonome d'un point de vue énergétique tout en ayant un faible impact sur l'environnement durant tout leur cycle de vie. Le système se base sur l'attribution de crédits pour chacun des critères. La somme de ces crédits détermine le niveau de certification obtenu. Le carrelage en céramique peut lui aussi contribuer à obtenir des crédits LEED. Ceramiche Atlas Concorde fait partie de l'US Green Building Council et est membre ordinaire du Green Building Council Italia, organisme de promotion de la thématique du LEED en Italie.

El estándar LEED (Leadership in Energy and Environmental Design) es un sistema de clasificación para el desarrollo de edificios “verdes”. Elaborado por el US Green Building Council y reconocido a nivel internacional, indica los requisitos para construir edificios eco-compatibles, capaces de funcionar de manera sostenible y autosuficiente a nivel energético y de tener un bajo impacto ambiental durante el ciclo de vida completo. El sistema se basa en la atribución de créditos por cada uno de los requisitos: de la suma de los puntos deriva el nivel de certificación obtenido. También los azulejos cerámicos pueden contribuir al conseguimiento de los puntos LEED. Ceramica Atlas Concorde es miembro del US Green Building Council y socio ordinario del Green Building Council Italia, ente promotor de los temas LEED en Italia.

Lo standard LEED (Leadership in Energy and Environmental Design) è un sistema di rating per lo sviluppo di edifici “verdi”. Elaborato dall'US Green Building Council e riconosciuto a livello internazionale, indica i requisiti per costruire edifici eco-compatibili, capaci di funzionare in maniera sostenibile ed autosufficiente a livello energetico e di avere un basso impatto sull'ambiente durante tutto il loro ciclo di vita. Il sistema si basa sull'attribuzione di crediti per ciascuno dei requisiti: dalla somma dei crediti deriva il livello di certificazione ottenuto. Anche le piastrelle ceramiche possono contribuire al raggiungimento dei crediti LEED. Ceramiche Atlas Concorde è membro dell'US Green Building Council e socio ordinario del Green Building Council Italia, ente promotore delle tematiche LEED in Italia.

Der LEED Standard (Leadership in Energy and Environmental Design) ist ein Bewertungssystem, das die Entwicklung “grüner” Gebäude fördert. Ausgearbeitet vom US Green Building Council ist dieser Standard international anerkannt und gibt Grundbedingungen für den Bau von öko-kompatiblen d.h. nachhaltigen und in Bezug auf Energie unabhängigen Gebäuden, die während ihres gesamten Lebenszyklus geringe Wirkung auf die Umwelt haben, vor. Das System beruht auf Credits, die man erhält, wenn diese Grundbedingungen des ökologischen Bauens erfüllt sind. Aus der Summe der Credits bestimmt sich das erreichte Zertifikationsniveau. Auch Fliesen können zum Erreichen der LEED Credits beitragen. Ceramiche Atlas Concorde ist Mitglied des US Green Building Council und ordentliches Mitglied des Green Building Council Italia, Förderer des LEED Konzepts in Italien.

LEED (Лидерство в области энергоэффективного и экологического проектирования) – признанная на международном уровне сертификационная система оценки зданий по степени экологической чистоты. Разработана Советом экологического строительства США (US Green Building Council) и устанавливает требования к проектированию и строительству зданий с точки зрения энергоэффективности, влияния на здоровье человека и окружающую среду. Система основывается на присвоении баллов по каждому из оценочных параметров, а по сумме накопленных баллов определяется уровень сертификации. Керамические плитки также могут содействовать получению баллов LEED. Ceramiche Atlas Concorde является членом Совета экологического строительства США и действительным членом Итальянского совета по экологическому строительству (Green Building Council Italia), одна из основных задач которого – распространение принципов LEED в Италии.

atlas concorde

MADE IN ITALY

The Made in Italy logo of Atlas Concorde stands for style, quality and ethics. Having firmly adhered to the Ethical Code promoted by Confindustria Ceramica, Atlas Concorde places the Made in Italy logo on all the products designed and produced in Italy, that is to say ceramic tiles, decorations and the majority of special trim tiles. Only a small amount of the latter is manufactured in Spain. Atlas Concorde products are produced using eco-friendly technologies, top quality and safe raw materials with the best working conditions guaranteed for our personnel. For these reasons, Atlas Concorde's Made in Italy is the expression of strong values such as style, design, product quality, and respect for the environment and the people who live in it.

Le label Made in Italy d'Atlas Concorde est synonyme de style, de qualité et d'éthique. Atlas Concorde a adhéré au Code Éthique de Confindustria Céramique avec conviction et appose le label Made in Italy sur tous les produits étudiés, projetés et fabriqués en Italie : dans ce cas, sur tous les carreaux en céramique, les décorations et la plupart des pièces spéciales. Seul un nombre restreint de ces dernières est fabriqué en Espagne. Les produits Atlas Concorde sont en outre fabriqués avec des technologies qui respectent l'environnement et utilisent des matières premières excellentes et sûres, dans la garantie des meilleurs conditions de travail. Pour ces raisons, le Made in Italy d'Atlas Concorde exprime des valeurs fortes telles que le style, le design, la qualité du produit et le respect de l'environnement et des personnes.

La marca Made in Italy de Atlas Concorde es sinónimo de estilo, calidad y ética. Adheriendo con convicción el Código Ético de Confindustria Cerámica, Atlas Concorde señala con la marca Made in Italy todos los productos estudiados, diseñados y realizados en Italia, en este caso todas las baldosas de cerámica, las decoraciones y la mayoría de piezas especiales. Sólo un restringido número de estas últimas se fabrica en España. Los productos Atlas Concorde se realizan además con tecnologías que respetan el medio ambiente, usando materias primas excelentes y seguras, garantizando las mejores condiciones de trabajo. Por dichas razones el Made in Italy de Atlas Concorde es la manifestación de valores sólidos como estilo, diseño, calidad del producto, cuidado del medio ambiente y las personas.



Ceramics of Italy

www.confindustriaceramica.it

The Ceramics of Italy logo is an exclusive identification on ceramic products which have effectively been made in Italy by companies that are a part of the Confindustria Ceramica and who adhered to its Ethical Code. This Code, promoted and created by Confindustria Ceramica, commits all companies to communicate, clearly and with transparency, the origin of their products.

Le label Ceramics of Italy distingue exclusivement les produits en céramique qui sont effectivement fabriqués en Italie par les sociétés associées à Confindustria Céramique ayant souscrit le Code Éthique. Ce Code, rédigé par Confindustria Céramique, engage ceux qui le souscrivent à communiquer clairement l'origine des produits.

La marca Ceramics of Italy distingue exclusivamente los productos cerámicos realizados efectivamente en Italia por una empresa afiliada a Confindustria Cerámica que ha suscrito el Código Ético. El Código, redactado por Confindustria Cerámica, compromete a quien lo ratifica a comunicar con claridad el origen de los productos.



www.eco-label.com

The European logo of environmental quality certifies compliance with the European environmental criteria and is only given to products that, compared to those of competitors, have a low environmental impact. Ecolabel is a quality award that identifies and promotes the most eco-friendly products. The environmental criteria evaluate the impact on the entire lifecycle: extraction of raw materials, manufacturing, distribution, use and final disposal.

Le label communautaire de qualité écologique certifie le respect de critères environnementaux au niveau européen et n'est délivré qu'aux produits qui ont un impact environnemental réduit par rapport aux concurrents. L'Ecolabel est donc une attestation d'excellence qui signale et promeut les produits les plus écologiques et respectueux de l'environnement. Les critères environnementaux considèrent l'impact pour chaque phase du cycle de vie : extraction des matières premières, processus de fabrication, distribution, utilisation, élimination.

La marca comunitaria de calidad ecológica certifica el respeto de los criterios ambientales establecidos a nivel europeo y es asignada exclusivamente a productos de impacto ambiental reducido respecto a la competencia. Ecolabel es entonces un atestado de excelencia que indica y promueve los productos altamente ecológicos y respetuosos con el ambiente. Los criterios ambientales evalúan el impacto en todas las fases del ciclo de vida: extracción de las materias primas, procesos de elaboración, distribución, uso y eliminación.

Il marchio Made in Italy di Atlas Concorde è sinonimo di stile, qualità ed etica. Avendo aderito con convinzione al Codice Etico di Confindustria Ceramica, Atlas Concorde appone il marchio Made in Italy su tutti i prodotti studiati, progettati e realizzati in Italia, nella fattispecie tutte le piastrelle di ceramica, le decorazioni e la maggioranza dei pezzi speciali. Solo un ristretto numero di questi ultimi è fabbricato in Spagna. I prodotti Atlas Concorde sono inoltre realizzati con tecnologie rispettose dell'ambiente, utilizzando materie prime eccellenti e sicure, garantendo le migliori condizioni di lavoro. Per queste ragioni il Made in Italy di Atlas Concorde è espressione di valori forti quali stile, design, qualità del prodotto, attenzione all'ambiente e alle persone.

Die Marke Made in Italy von Atlas Concorde ist ein Synonym für Stil, Qualität und Ethik. Aus Überzeugung haben wir uns dem Ethischen Kodex der Confindustria Ceramica (Dachverband der ital. Unternehmen und Unternehmensverbände der Keramikbranche) angeschlossen. Atlas Concorde bringt die Marke Made in Italy auf allen seinen Produkten an die in Italien geplant, entwickelt und realisiert werden, d.h. alle Keramikfliesen, Dekore, Bordüren und der Hauptteil der Spezialteile. Nur eine geringe Anzahl der letzteren werden in Spanien gefertigt. Die Produkte von Atlas Concorde werden darüberhinaus unter Verwendung ausgezeichneter und sicherer Rohstoffe mittels umweltschützender Technologien unter besten Arbeitsbedingungen hergestellt. Aus diesen Gründen ist Made in Italy von Atlas Concorde ein Ausdruck starker Werte wie Stil, Design, Produktqualität.

Маркировка Made in Italy на плитках Atlas Concorde – синоним стиля, качества и этики. С уверенностью приняв «Этический кодекс» федерации Confindustria Ceramica (ассоциация предприятий керамической отрасли), компания отмечает этим знаком все изделия, разработанные и изготовленные в Италии: керамические плитки, декоры и большинство специальных элементов. Лишь ограниченная часть последних производится в Испании. Изделия Atlas Concorde изготовлены с использованием надежного, высококачественного сырья и передовых технологий, гарантирующих экологическую совместимость производства и оптимальные рабочие условия. Для Atlas Concorde Made in Italy – это выражение важных ценностей, таких как стиль, дизайн, качество. Это уважение к человеку и природе.

Il marchio Ceramics of Italy contrassegna esclusivamente i prodotti ceramici effettivamente realizzati in Italia da un'azienda associata a Confindustria Ceramica che ha sottoscritto il Codice Etico. Il Codice, redatto dalla stessa Confindustria Ceramica, impegna a comunicare con chiarezza l'origine dei prodotti.

Die Marke Ceramics of Italy zeichnet ausschließlich Keramikprodukte aus, die in Italien, von Unternehmen, welche dem Dachverband der ital. Unternehmen und Unternehmensverbände der Keramikbranche angehören und sich dem Ethischen Kodex verschrieben haben, hergestellt werden. Der Kodex, von diesem Dachverband ins Leben gerufen, verpflichtet sich zur klaren Angabe und Mitteilung der Herkunft der Produkte.

Знаком Ceramics of Italy маркируются только керамические изделия, которые изготовлены действительно в Италии предприятием-членом федерации Confindustria Ceramica, подписавшим “Этический кодекс”. Кодекс разработан самой федерацией и обяывает ясно указывать происхождение товара.

Il marchio comunitario di qualità ecologica certifica il rispetto di criteri ambientali stabiliti a livello europeo ed è rilasciato esclusivamente a prodotti con un ridotto impatto ambientale rispetto ai concorrenti. Ecolabel è quindi un attestato di eccellenza che segnala e promuove i prodotti più ecologici e rispettosi dell'ambiente. I criteri ambientali valutano l'impatto in tutte le fasi del ciclo di vita: estrazione delle materie prime, processi di lavorazione, distribuzione, utilizzo, smaltimento.

Die Marke ökologischer Qualität der europäischen Gemeinschaft, das europäische Umweltzeichen (Ecolabel), bestätigt die Einhaltung umweltschonender Produktionskriterien, die auf europäischer Ebene vereinbart worden sind, und wird ausschließlich an Produkte, deren Auswirkungen auf die Umwelt im Vergleich zu Mitbewerbern gering sind, verliehen. Ecolabel ist ein Attest für Außergewöhnlichkeit und fördert und unterstützt ökologische und umweltverträgliche Produkte. Die umweltschonende Kriterien gelten in allen Phasen des Lebenszyklus eines Produktes: beim Abbau von Rohstoffen, bei Bearbeitungsprozessen, beim Vertrieb und bei der Entsorgung.

Знак экологического качества ЕС удостоверяет соблюдение экологических требований, установленных на европейском уровне, и присваивается товарам, оказывающим меньшее воздействие на окружающую среду, по сравнению с существующими аналогами. Следовательно, Ecolabel является свидетельством безопасности продукции и внимательного отношения производителя к вопросам охраны природы. При выдаче сертификата оценивается воздействие изделий на среду на протяжении всего их жизненного цикла: от добычи сырья и производства до сбыта, эксплуатации и утилизации.



atlas concorde

CERAMICHE ATLAS CONCORDE S.P.A.
41042 Spezzano di Fiorano (MO) Italia - Via Canaletto, 141
info@atlasconcorde.it - www.atlasconcorde.it

ATLAS CONCORDE USA, INC.
2830 SW 42 Street - Hollywood, FL 33312 - U.S.A.

OOO "ATLAS CONCORDE RUSSIA"
Business centre "Meliora Place" - Prospekt Mira 6 - 129090 Mosca, Russia
info@atlasconcorde.ru - www.atlasconcorde.ru

Copyright 2013 by Ceramiche Atlas Concorde S.p.A. (Spezzano di Fiorano, MO - Italy)